

TECHSPEC® 16mm, f/1.6 Ci Series Fixed Focal Length Lens



16mm Focal Length

Stock **#85-348** **9 In Stock**

⊖ 1 ⊕ C\$491⁰⁰

ADD TO CART

Volume Pricing	
Qty 1-24	C\$491.40 each
Qty 25+	C\$442.40 each
Need More?	Request Quote

Product Downloads

General

Ci Series **Series:**

Fixed Focal Length Lens **Type:**

Compact Lens with Fixed Aperture **Imaging Lens Type:**

Physical & Mechanical Properties

Iris Option:

Fixed	
40.80	Length (mm):
26.5	Maximum Diameter (mm):
26.5	Outer Diameter (mm):
37	Weight (g):
1.09	Maximum Rear Protrusion (mm):
26.50	Diameter (mm):

Optical Properties

61.4mm - 30.9°	Horizontal Field of View @ Max Sensor Format:
Horizontal: 59.8mm - 31° Vertical: 44.6mm - 23.4° Diagonal: 75.1mm - 38.3°	Field of View at Max Sensor Format:
61.4mm - 30.9°	Horizontal Field of View, 2/3" Sensor:
50.1mm - 25.2°	Horizontal Field of View, 1/1.8" Sensor:
44.5mm - 22.7°	Horizontal Field of View, 1/2" Sensor:
39.6mm - 20.2°	Horizontal Field of View, 1/2.5" Sensor:
33.3mm - 17.1°	Horizontal Field of View, 1/3" Sensor:
25mm - 12.8°	Horizontal Field of View, 1/4" Sensor:
11.00	Maximum Image Circle (mm):
0.0445	Numerical Aperture NA, Object Side:
7 (6)	Number of Elements (Groups):
16.00	Focal Length FL (mm):
100 - ∞	Working Distance (mm):
f/1.6	Aperture (f/#):
425 - 675nm BBAR	Coating:
425 - 675nm BBAR	Coating Specification:
9.12	Entrance Pupil Position (mm):
21.30	Object Space Principal Plane (mm):
-3.00	Image Space Principal Plane (mm):
-1.26	Maximum Distortion (%):
-53.79	Exit Pupil Position (mm):
VIS	Lens Wavelength Range:

Sensor

2/3"	Maximum Sensor Format:
2.74	Pixel Size (µm):

Threading & Mounting

M25.5 x 0.50 (Male)	Filter Thread:
#89-942 (Required)	Filter Thread Adapter:
M22.0 x 0.75 (Male)	Front Thread:

C-Mount **Mount:**

Environmental & Durability Factors

Storage Temperature (°C):
-20 to +60

Type of Ruggedization:
Industrial (Fixed Aperture with Simplified Mechanics)

Regulatory Compliance

RoHS 2015:
Compliant

REACH 201:
Compliant

Certificate of Conformance:
[View](#)

Product Details

These compact lenses are designed specifically for volume integration into applications such as analytical medical devices, including benchtop-based blood analyzers. For customized *f*# versions to best suit your instrumentation application needs and to discuss volume requirements, please [contact us](#).

- Up to 2/3", C-Mount Lens
- Up to 7.5 MegaPixels, 2.8µm Pixel Size Sensors
- Instrumentation (Ci) Versions of our C Series Lenses with Streamlined Mechanical Designs and Fixed Apertures
- 3.5mm to 50mm Focal Length
- [Ruggedized \(Cr\) Designs](#) Also Available

TECHSPEC® Ci Series Fixed Focal Length Lenses are a streamlined version of our C Series Fixed Focal Length Lenses. They feature the same low lens-to-lens variation and broadband anti-reflection (BBAR) coating for maximum light transmission, while offering reduced weight and size. An adjustable, lockable focus allows for setting and locking the best focus position for instrumentation integration. TECHSPEC® Ci Series Fixed Focal Length Lenses are designed specifically for volume integration into applications such as factory inspection and automation to benchtop biomedical devices. The Ci Series offers a wide range of aperture options, ensuring maximum flexibility of resolution, throughput, and depth of field.

Edmund Optics has created a family of high performance optical designs (the C Series family) and developed 6 customized optomechanical solutions targeted for specific applications. These lens sub-families utilize the same optics as the C Series lenses providing the same optical performance in a variety of optomechanical solutions to meet your application requirements:

- **C Series:** Features locking cam focus and iris adjustment and is the most adjustable version of these optical designs; they are the typical high quality machine vision lenses. Also available with a [VIS-NIR Broadband Anti-Reflection \(BBAR\) Coating](#).
- **Ci Series:** Simplified mechanics featuring fixed apertures with compact housing. [Industrial Ruggedization](#) for reduced size, cost, and locked focus.
- **Cr Series:** All optics glued in place and a locking C-clamp focus ring. [Stabilized Ruggedization](#) for reduced pixel shift and improved focus stability.
- **Cx Series:** Modular, flexible mechanics allows lenses to be taken apart for easy integration of accessories such as liquid lenses, apertures, and more.
- **Liquid Lens Cx Series:** Designed with an integrated liquid lens for quick autofocus.
- **Cw Series:** Waterproof, designed to meet IEC [Ingress Protection](#) Code IPX7 and IPX9K.

Technical Information

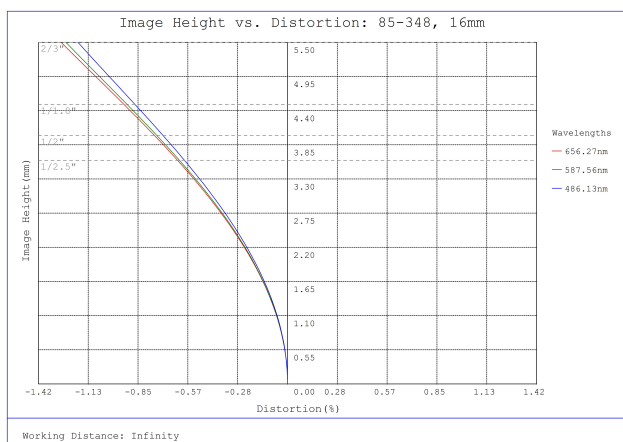

#85-348, 16mm, f/1.6 Ci Series Fixed Focal Length Lens, Distortion Plot

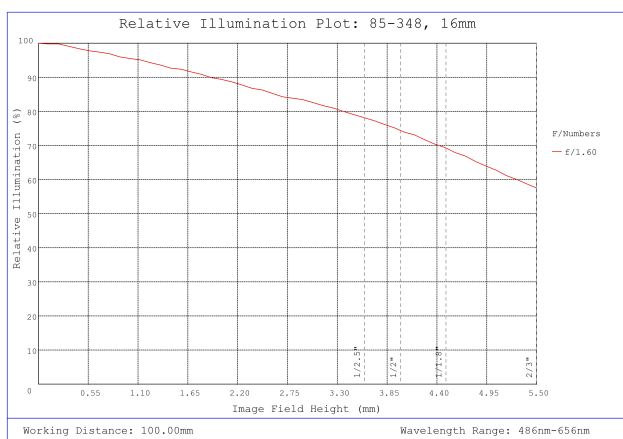

#85-348, 16mm, f/1.6 Ci Series Fixed Focal Length Lens, Relative Illumination Plot

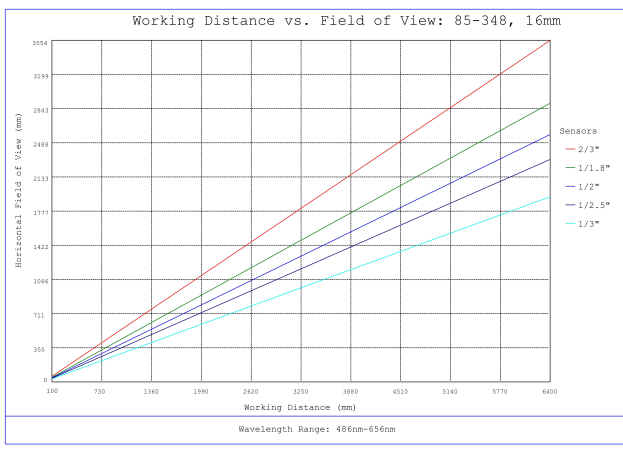

#85-348, 16mm, f/1.6 Ci Series Fixed Focal Length Lens, Working Distance versus Field of View Plot

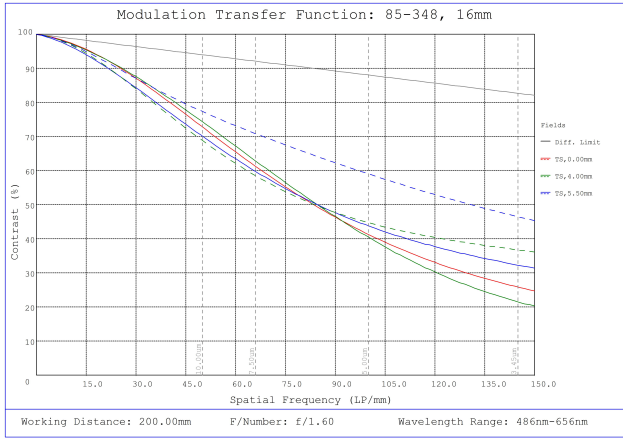

#85-348, 16mm, f/1.6 Ci Series Fixed Focal Length Lens, Modulated Transfer Function (MTF) Plot, 200mm Working Distance, f1.6

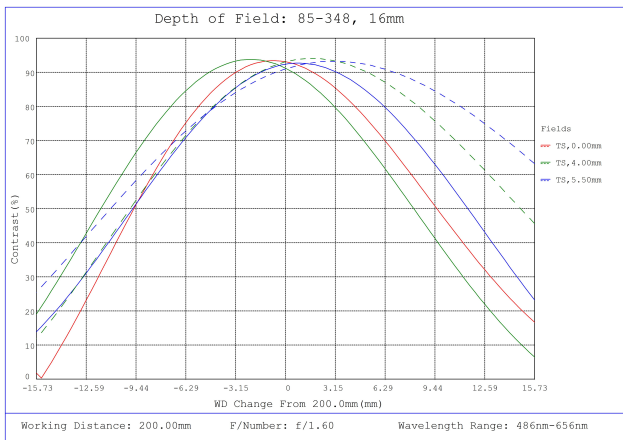

#85-348, 16mm, f/1.6 Ci Series Fixed Focal Length Lens, Depth of Field Plot, 200mm Working Distance, f1.6

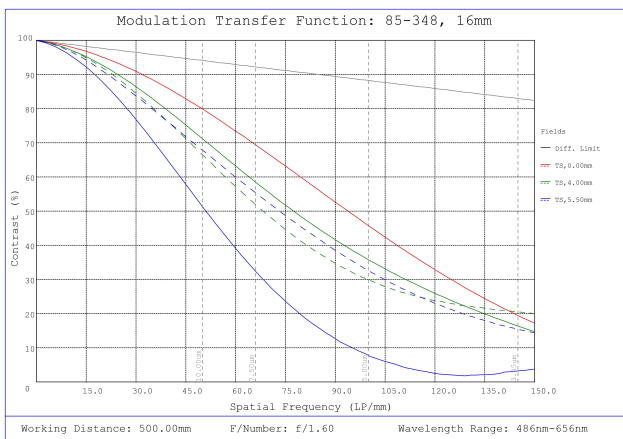

#85-348, 16mm, f/1.6 Ci Series Fixed Focal Length Lens, Modulated Transfer Function (MTF) Plot, 500mm Working Distance, f1.6

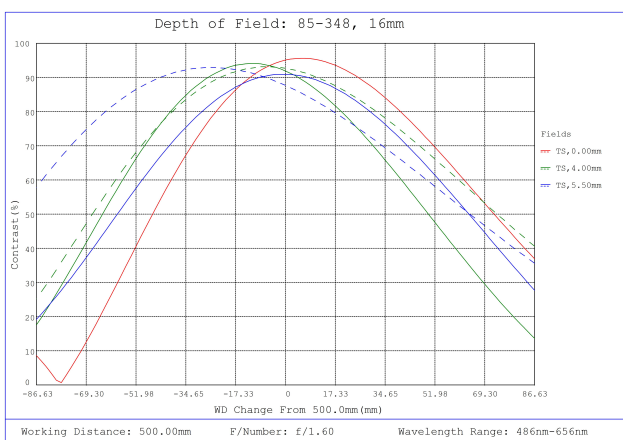

#85-348, 16mm, f/1.6 Ci Series Fixed Focal Length Lens, Depth of Field Plot, 500mm Working Distance, f1.6

Focal Length	A	B	C	D
6mm	M34.0 x 0.5	47.8mm	34mm	1.17mm
12mm	M22.0 x 0.75	29.0mm	22mm	0.96mm
16mm	M22.0 x 0.75	40.8mm	22mm	1.09mm
25mm	M22.0 x 0.75	29.9mm	22mm	1.33mm
35mm	M25.5 x 0.5	41mm	22.5mm	3.82mm
50mm	M30.5 x 0.5	49.5mm	30.5mm	2.06mm

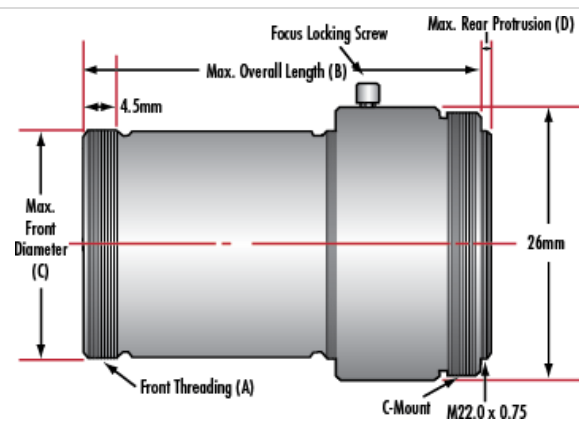

Compatible Cameras
