

TECHSPEC® 18mm VIS 0° Coated Dove Prism



Stock #49-427 **3 In Stock**

⊖ 1 ⊕ C\$246⁰⁰

ADD TO CART

Volume Pricing	
Qty 1-5	C\$246.40 each
Qty 6-25	C\$222.60 each
Qty 26-49	C\$197.40 each
Need More?	Request Quote

Product Downloads

General

Dove Prism **Type:**

Physical & Mechanical Properties

18.0 **Height (mm):**

74.60 **Length (mm):**

Dimensional Tolerance (mm):
±0.13 Legs, ±0.25 Length

Bevel:
Protective as needed

Optical Properties

Coating:
MS 0° (425-675nm)

Substrate:
N-BK7

Surface Quality:
60-40

Angle Tolerance (arcmin):
2.00

Image Orientation:
Left-Handed

Coating Specification:
 $R_{avg} \leq 0.4\%$ @ 425 - 675nm

Ray Deviation (°):
0

Wavelength Range (nm):
425 - 675

Damage Threshold, Reference:
5 J/cm² @ 532nm, 10ns

Power (fringes) @ 632.8nm:
0.50

Irregularity (fringes) @ 632.8nm:
0.25

Regulatory Compliance

RoHS 2015:
Compliant

Certificate of Conformance:
View

Reach 247:
Compliant

Need different specs or modifications?

Edmund Optics offers comprehensive custom manufacturing services for optical and imaging components tailored to your specific application requirements. Whether in the prototyping phase or preparing for full-scale production, we provide flexible solutions to meet your needs. Our experienced engineers are here to assist—from concept to completion.

Our capabilities include:

- Custom dimensions, materials, coatings, and more
- High-precision surface quality and flatness
- Tight tolerances and complex geometries
- Scalable production—from prototype to volume

Learn more about our [custom manufacturing capabilities](#) or submit an inquiry [here](#).

Product Details

- Image Rotation of 180°
- Left Handed Image
- Ideal for Rotation, Inversion or Displaced Retroreflection

TECHSPEC® Dove Prisms have an unusual and fascinating characteristic. If you look through the prism and rotate it around a longitudinal axis, the image rotates through twice the angle through which the dove prism itself rotates. In this use, with light incident on either of the smaller diagonal surfaces, light is reflected off the bottom surface, and the image inverted, allowing both inversion of the image, as well as rotation. Dove prisms can also be used as retroreflectors, when light is incident off the longest face. For optimal performance, use dove prisms with collimated light. The top surface of each dove prism is ground, and the longest length (specified by dimension B) features an unbeveled sharp edge.

TECHSPEC® Dove Prisms are offered uncoated, with anti-reflection coated diagonal faces or with aluminized diagonal faces. Uncoated dove prisms can be used for either image rotation or retroreflection and use total internal reflection for effective image transmission. AR coated dove prisms are specifically designed for use for image rotation and inversion, with improved throughput compared to uncoated prisms. Please note, this makes them unsuitable for use as retroreflectors. Aluminized dove prisms feature a protected aluminum coating with black Krylon paint on the diagonal faces and are ideal for displaced retroreflection. They provide a U-turn for incident laser beam light.

Technical Information



ALUMINIZED



Stock No.	A	B	C	D
#32-998	5.00mm	20.64mm	5.00mm	7.07mm
#49-424				
#32-999	10.0mm	43.56mm	10.0mm	14.14mm
#49-425				
#32-553	15.00mm	62.50mm	15.00mm	21.21mm
#49-426				
#49-427	18.00mm	76.10mm	18.00mm	25.45mm
#32-554	20.00mm	79.80mm	20.00mm	28.28mm
#49-428				
#45-403	25.00mm	103.18mm	25.00mm	35.36mm



Image Rotation Ray Path

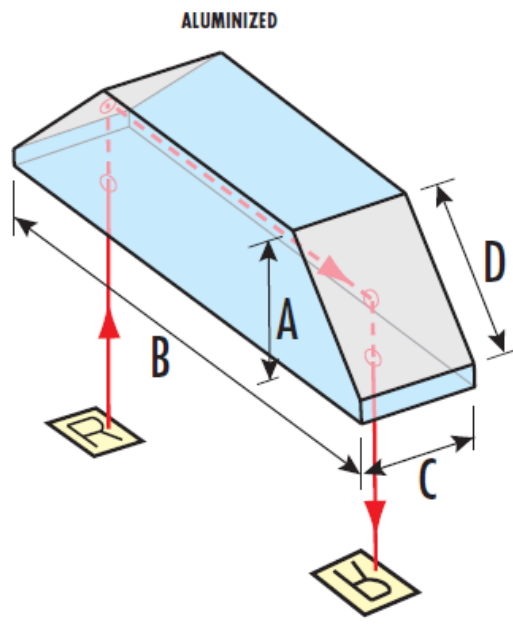

Displaced Retroreflector Ray Path

Coating Curves
