

**TECHSPEC® 20.0mm Dia. x 30.0mm FL, MgF<sub>2</sub> Coated, Plano-Convex Lens**



Stock **#45-240** **20+ In Stock**

[Other Coating Options](#)

1  C\$58.<sup>00</sup>

**ADD TO CART**

Volume Pricing	
Qty 1-9	C\$58.80 each
Qty 10-24	C\$52.50 each
Qty 25-49	C\$47.25 each
Need More?	<a href="#">Request Quote</a>

Product Downloads

**General**

Plano-Convex Lens **Type:**

**Physical & Mechanical Properties**

20.00 +0.0/-0.025 **Diameter (mm):**

<1	Centering (arcmin):
4.50 ±0.10	Center Thickness CT (mm):
1.84	Edge Thickness ET (mm):
19	Clear Aperture CA (mm):
Protective as needed	Bevel:
<b>Optical Properties</b>	
30.00 @ 587.6nm	Effective Focal Length EFL (mm):
27.30	Back Focal Length BFL (mm):
MgF <sub>2</sub> (400-700nm)	Coating:
R <sub>avg</sub> ≤1.75% @ 400 - 700nm	Coating Specification:
<a href="#">N-BAF10</a>	Substrate: <input type="checkbox"/>
40-20	Surface Quality:
1.5λ	Power (P-V) @ 632.8nm:
λ/4	Irregularity (P-V) @ 632.8nm:
±1	Focal Length Tolerance (%):
20.10	Radius R <sub>1</sub> (mm):
1.5	f#:
0.33	Numerical Aperture NA:
400 - 700	Wavelength Range (nm):
10 J/cm <sup>2</sup> @ 532nm, 10ns	Damage Threshold, By Design: <input type="checkbox"/>

<b>Regulatory Compliance</b>	
<a href="#">Compliant</a>	RoHS 2015:
<a href="#">Compliant</a>	Reach 219:
<a href="#">View</a>	Certificate of Conformance:

## Need different specs or modifications?

Edmund Optics offers comprehensive custom manufacturing services for optical and imaging components tailored to your specific application requirements. Whether in the prototyping phase or preparing for full-scale production, we provide flexible solutions to meet your needs. Our experienced engineers are here to assist—from concept to completion.

Our capabilities include:

- Custom dimensions, materials, coatings, and more
- High-precision surface quality and flatness
- Tight tolerances and complex geometries
- Scalable production—from prototype to volume

Learn more about our [custom manufacturing capabilities](#) or submit an inquiry [here](#).

## Product Details

- AR Coated to Provide <1.75% Reflectance per Surface for 400 - 700nm
- Designed for 0° Angle of Incidence
- Various PCX Coating Options: [Uncoated](#), [VIS 0°](#), [VIS-NIR](#), [NIR I](#), [NIR II](#), [VIS-EXT](#), and [YAG-BBAR](#)
- Also Available [Pre-Mounted in Engraved C-Mount Housings](#)

TECHSPEC® MgF<sub>2</sub> Coated Plano-Convex (PCX) Lenses have a positive focal length, making them ideal for collecting and focusing light in imaging applications. They are also useful in a variety of applications involving emitters, detectors, lasers, and fiber optics. TECHSPEC® MgF<sub>2</sub> Coated Plano-Convex (PCX) Lenses are available in a wide variety of diameters and focal lengths. Identical designs of these PCX lenses are also offered [uncoated](#) or with broadband anti-reflective (BBAR) coatings, which include [VIS 0°](#), [VIS-NIR](#), [NIR I](#), [NIR II](#), [VIS-EXT](#), and [YAG-BBAR](#).

## Technical Information

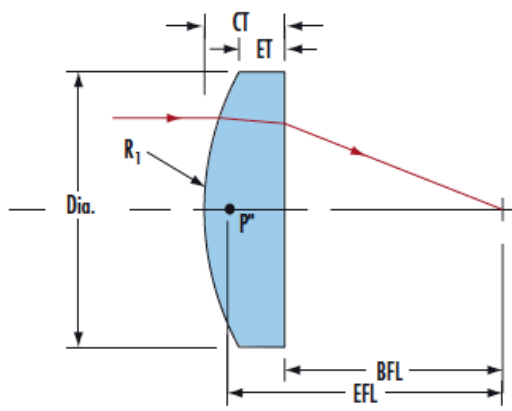

N-BK7

### Uncoated N-BK7 Typical Transmission

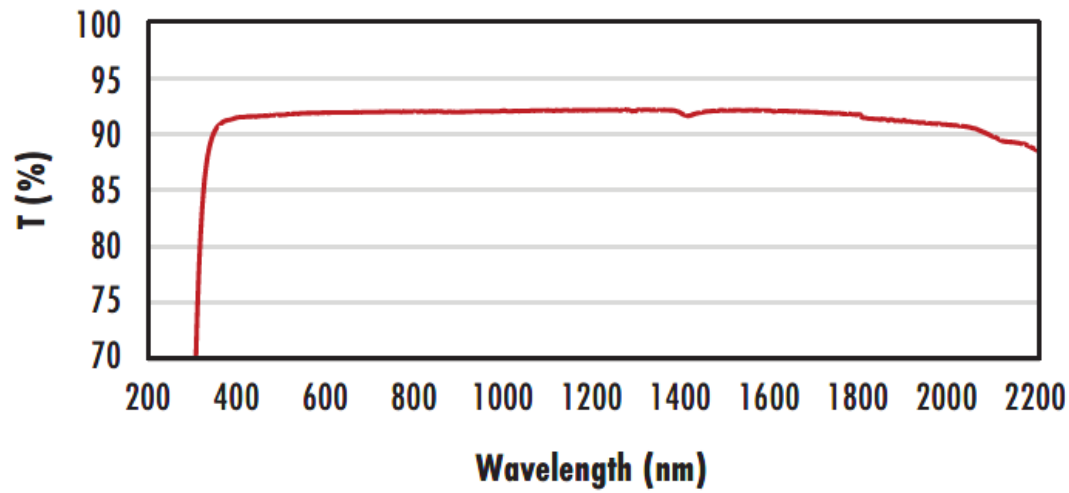

Typical transmission of a 3mm thick, uncoated N-BK7 window across the UV - NIR spectra.

[Click Here to Download Data](#)

### N-BK7 with MgF<sub>2</sub> Coating Typical Transmission

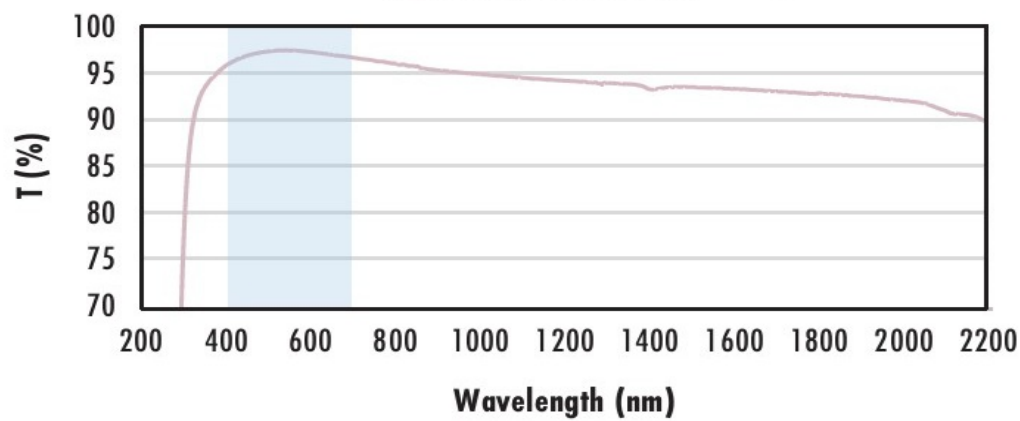

Typical transmission of a 3mm thick N-BK7 window with MgF<sub>2</sub> (400-700nm) coating at 0° AOI.

The blue shaded region indicates the coating design wavelength range, with the following specification:

$$R_{avg} \leq 1.75\% @ 400 - 700\text{nm (N-BK7)}$$

Data outside this range is not guaranteed and is for reference only.

[Click Here to Download Data](#)

### N-BK7 with VIS-EXT Coating Typical Transmission

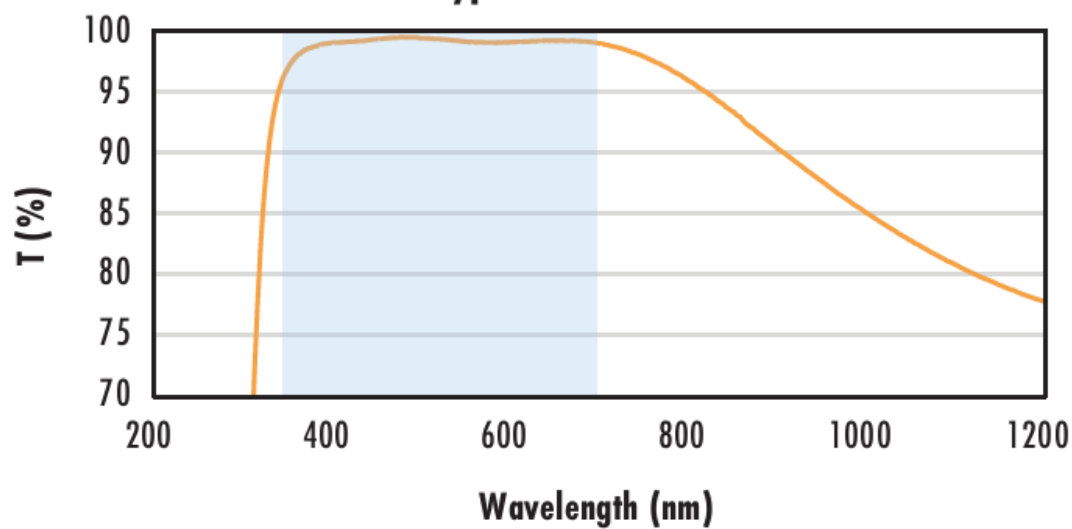

Typical transmission of a 3mm thick N-BK7 window with VIS-EXT (350-700nm) coating at 0° AOI.

The blue shaded region indicates the coating design wavelength range, with the following specification:

$$R_{avg} \leq 0.5\% @ 350 - 700\text{nm}$$

Data outside this range is not guaranteed and is for reference only.

[Click Here to Download Data](#)

### N-BK7 with VIS-NIR Coating Typical Transmission

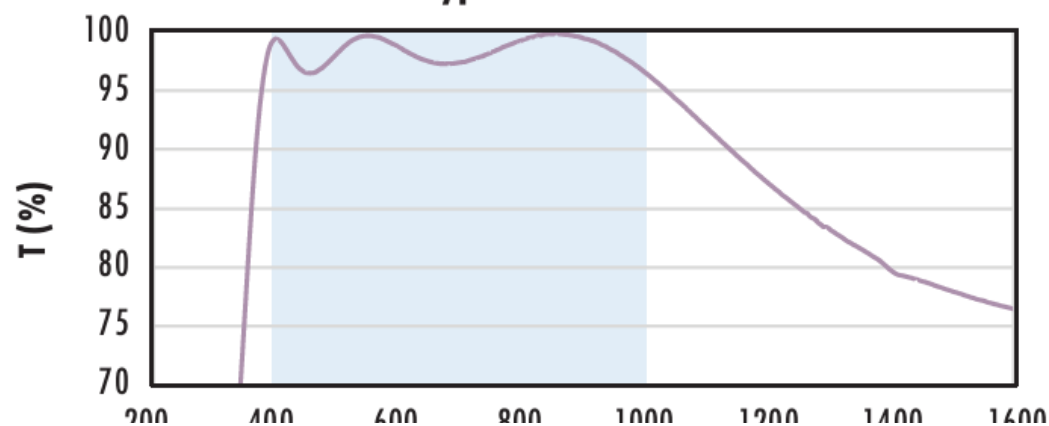

Typical transmission of a 3mm thick N-BK7 window with VIS-NIR (400-1000nm) coating at 0° AOI.

The blue shaded region indicates the coating design wavelength range, with the following specification:

$$R_{abs} \leq 0.25\% @ 880\text{nm}$$

$$R_{avg} \leq 1.25\% @ 400 - 870\text{nm}$$

$$R_{avg} \leq 1.25\% @ 890 - 1000\text{nm}$$

Data outside this range is not guaranteed and is for reference only.

[Click Here to Download Data](#)

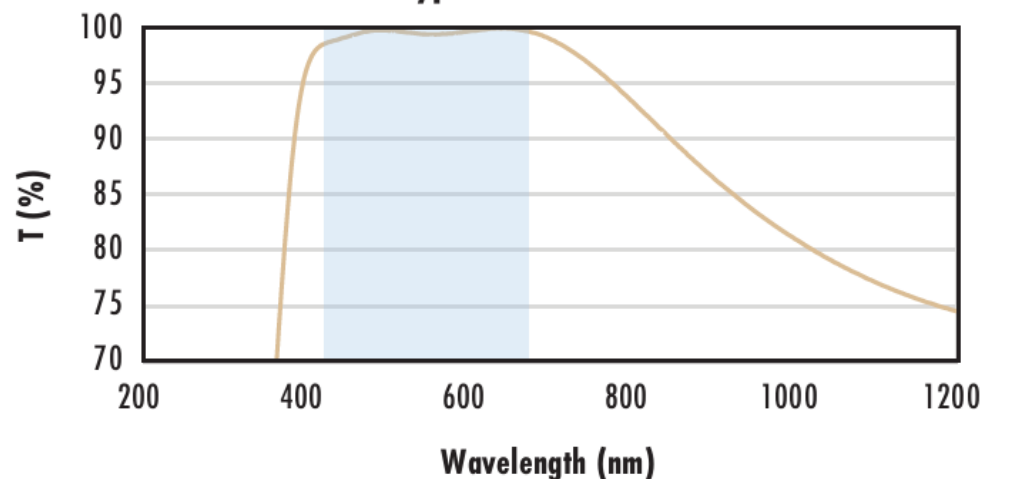
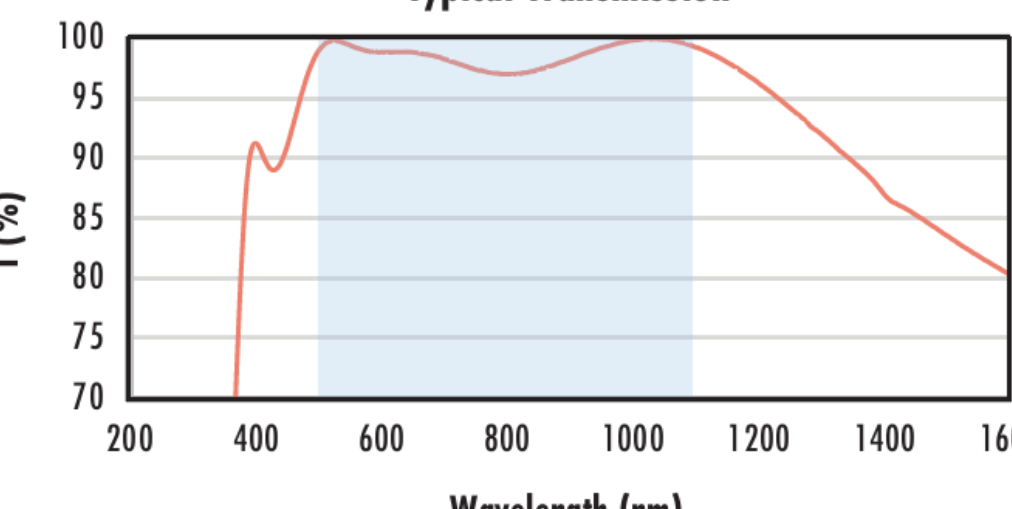
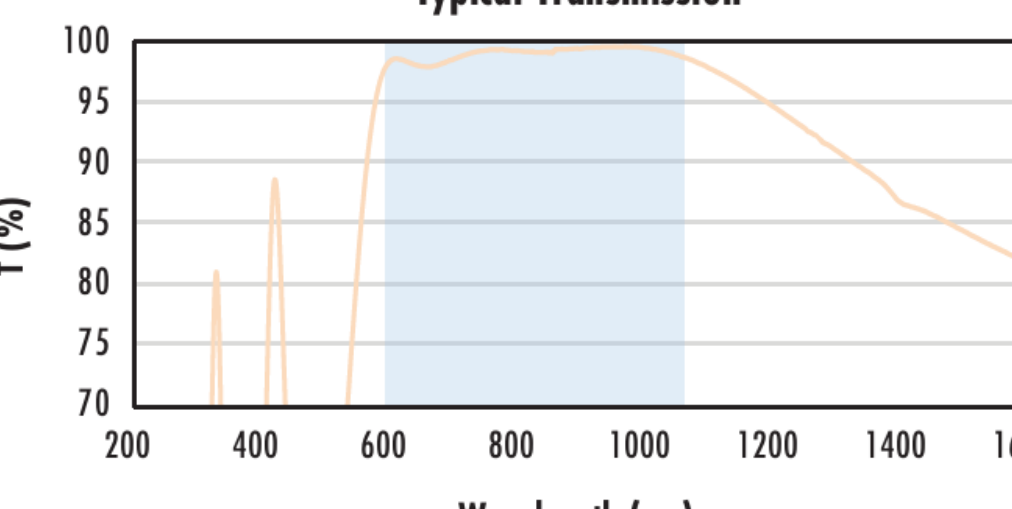
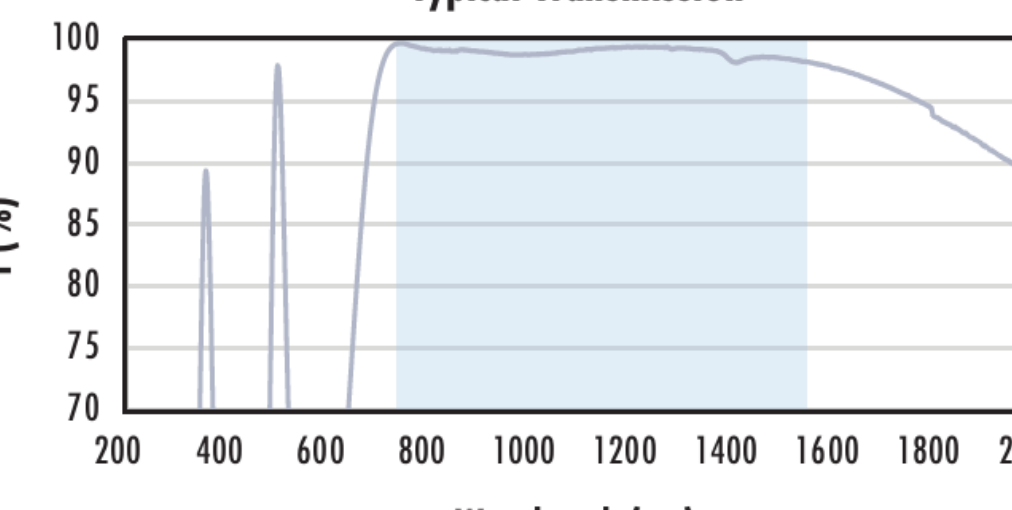
<p style="text-align: center;">200    400    600    800    1000    1200    1400    1600</p> <p style="text-align: center;"><b>Wavelength (nm)</b></p>	
<p style="text-align: center;"><b>N-BK7 with VIS 0° Coating</b> <b>Typical Transmission</b></p> 	<p>Typical transmission of a 3mm thick N-BK7 window with VIS 0° (425-675nm) coating at 0° AOI.</p> <p>The blue shaded region indicates the coating design wavelength range, with the following specification:</p> <p style="text-align: center;"><math>R_{avg} \leq 0.4\% @ 425 - 675\text{nm}</math></p> <p>Data outside this range is not guaranteed and is for reference only.</p> <p style="text-align: center;"><a href="#">Click Here to Download Data</a></p>
<p style="text-align: center;"><b>N-BK7 with YAG-BBAR Coating</b> <b>Typical Transmission</b></p> 	<p>Typical transmission of a 3mm thick N-BK7 window with YAG-BBAR (500-1100nm) coating at 0° AOI.</p> <p>The blue shaded region indicates the coating design wavelength range, with the following specification:</p> <p style="text-align: center;"><math>R_{abs} \leq 0.25\% @ 532\text{nm}</math> <math>R_{abs} \leq 0.25\% @ 1064\text{nm}</math> <math>R_{avg} \leq 1.0\% @ 500 - 1100\text{nm}</math></p> <p>Data outside this range is not guaranteed and is for reference only.</p> <p style="text-align: center;"><a href="#">Click Here to Download Data</a></p>
<p style="text-align: center;"><b>N-BK7 with NIR I Coating</b> <b>Typical Transmission</b></p> 	<p>Typical transmission of a 3mm thick N-BK7 window with NIR I (600 - 1050nm) coating at 0° AOI.</p> <p>The blue shaded region indicates the coating design wavelength range, with the following specification:</p> <p style="text-align: center;"><math>R_{avg} \leq 0.5\% @ 600 - 1050\text{nm}</math></p> <p>Data outside this range is not guaranteed and is for reference only.</p> <p style="text-align: center;"><a href="#">Click Here to Download Data</a></p>
<p style="text-align: center;"><b>N-BK7 with NIR II Coating</b> <b>Typical Transmission</b></p> 	<p>Typical transmission of a 3mm thick N-BK7 window with NIR II (750 - 1550nm) coating at 0° AOI.</p> <p>The blue shaded region indicates the coating design wavelength range, with the following specification:</p> <p style="text-align: center;"><math>R_{abs} \leq 1.5\% @ 750 - 800\text{nm}</math> <math>R_{abs} \leq 1.0\% @ 800 - 1550\text{nm}</math> <math>R_{avg} \leq 0.7\% @ 750 - 1550\text{nm}</math></p> <p>Data outside this range is not guaranteed and is for reference only.</p> <p style="text-align: center;"><a href="#">Click Here to Download Data</a></p>

**Coating Curves**

## Compatible Mounts

---