

25.4mm Dia, 900 - 2100nm, $\lambda/4$ Achromatic Waveplate



Achromatic Waveplates (Retarders)

Stock **#39-050** **2 In Stock**

⊖ 1 ⊕ C\$1,610⁰⁰

ADD TO CART

| Volume Pricing | |
|----------------|-------------------------------|
| Qty 1-5 | C\$1,610.00 each |
| Qty 6+ | C\$1,400.00 each |
| Need More? | Request Quote |

Product Downloads

General

Achromatic Waveplate **Type:**

Air Spaced **Configuration:**

Physical & Mechanical Properties

>20.0 **Clear Aperture CA (mm):**

Diameter (mm):

25.40

6.00 ±0.2 **Thickness (mm):**

+0/-0.25 **Dimensional Tolerance (mm):**

Crystalline **Construction:**

<10 **Parallelism (arcsec):**

+0/-0.25 **Housing Tolerance (mm):**

Optical Properties

$R_{avg} < 0.75\%$ @ 900 - 2100nm **Coating:**

Crystal Quartz and MgF₂ **Substrate:** □

$\lambda/4$ **Retardance:**

40-20 **Surface Quality:**

< $\lambda/4$ @ 632nm **Transmitted Wavefront, P-V:**

$\lambda/100$ @ 20°C **Retardance Tolerance:**

$R_{avg} < 0.75\%$ @ 900 - 2100nm **Coating Specification:**

900 - 2100 **Wavelength Range (nm):**

>5 J/cm² @ 1064nm, 10ns, 10Hz **Damage Threshold, By Design:** □

Regulatory Compliance

Compliant **RoHS 2015:**

View **Certificate of Conformance:**

Compliant **Reach 247:**

Product Details

- Multiple Wavelength Ranges Available
- Flat Response Over Each Broad Spectral Range
- $\lambda/4$ and $\lambda/2$ Retardance
- Mounted in Black Anodized Aluminum Housing

Achromatic Waveplates (Retarders) provide a constant phase shift independent of the wavelength of light that is used. This wavelength independence is achieved by using two different birefringent crystalline materials. The relative shifts in retardation over the wavelength range are balanced between the two materials used. Achromatic Waveplates (Retarders), with their flat response, are ideal for use with tunable lasers, multiple laser line systems, and other broad-spectrum sources.

Designed to be used at an angle of incidence of 0°, changes of ±3° will yield less than 1% change in retardance. The 23mm clear aperture waveplates will feature a cemented construction. All Achromatic Waveplates (Retarders) are mounted in an anodized aluminum housing with the fast axis clearly indicated.

Technical Information

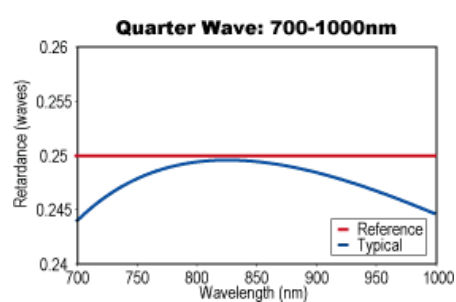
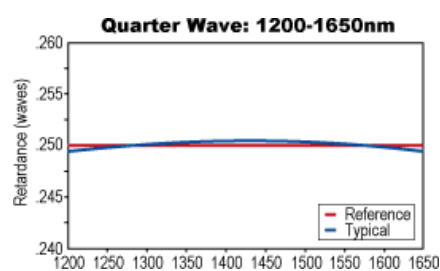

25.4mm Diameter Waveplates

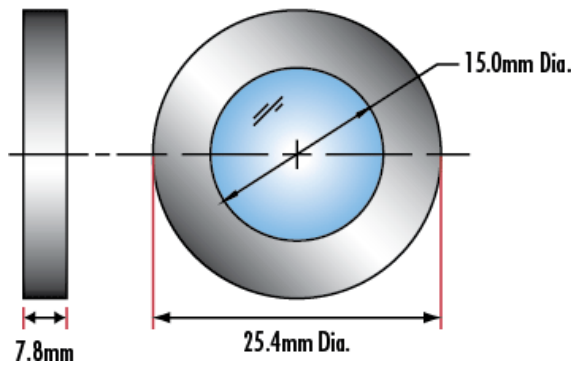

Half Wave: 1200-1650nm

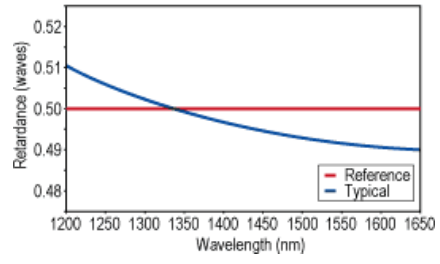

Half Wave: 700-1000nm

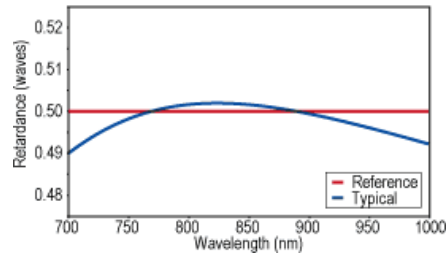

Half Wave: 465-610nm

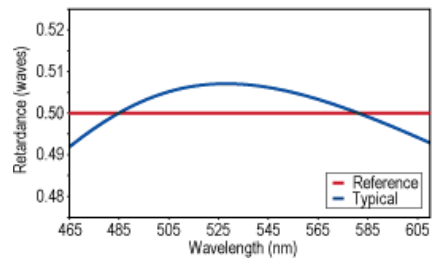

Quarter Wave: 465-610nm

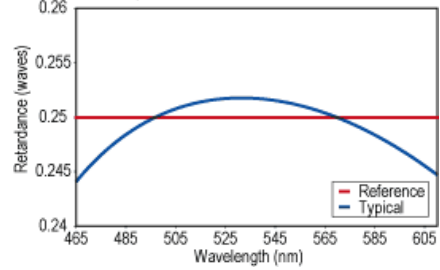

30.0mm Diameter Waveplates

