

TECHSPEC® 25mm Dia. x 50mm FL UV-AR Coated, UV Plano-Convex Lens



UV Fused Silica Plano-Convex (PCX) Lenses



Stock #48-284 **20+ In Stock**

- 1 + C\$250.⁰⁰

ADD TO CART

Volume Pricing	
Qty 1-5	C\$250.60 each
Qty 6-25	C\$200.20 each
Qty 26-49	C\$187.60 each
Need More?	Request Quote

Product Downloads

General

Plano-Convex Lens **Type:**

Physical & Mechanical Properties

25.00 +0.0/-0.025 **Diameter (mm):**

<1	Centering (arcmin):
5.84 ±0.10	Center Thickness CT (mm):
2.13	Edge Thickness ET (mm):
24	Clear Aperture CA (mm):
Protective as needed	Bevel:
Optical Properties	
50.00 @ 587.6nm	Effective Focal Length EFL (mm):
46.00	Back Focal Length BFL (mm):
UV-AR (250-425nm)	Coating:
R _{abs} ≤1.0% @ 250 - 425nm R _{avg} ≤0.75% @ 250 - 425nm R _{avg} ≤0.5% @ 370 - 420nm	Coating Specification:
Fused Silica (Corning 7980)	Substrate: <input type="checkbox"/>
40-20	Surface Quality:
1.5λ	Power (P-V) @ 632.8nm:
λ/4	Irregularity (P-V) @ 632.8nm:
±1	Focal Length Tolerance (%):
22.92	Radius R₁ (mm):
2	f#:
0.25	Numerical Aperture NA:
250 - 425	Wavelength Range (nm):
3 J/cm ² @ 355nm, 10ns	Damage Threshold, Reference: <input type="checkbox"/>

Regulatory Compliance	
Compliant	RoHS 2015:
View	Certificate of Conformance:
Compliant	Reach 235:

Need different specs or modifications?

Edmund Optics offers comprehensive custom manufacturing services for optical and imaging components tailored to your specific application requirements. Whether in the prototyping phase or preparing for full-scale production, we provide flexible solutions to meet your needs. Our experienced engineers are here to assist—from concept to completion.

Our capabilities include:

- Custom dimensions, materials, coatings, and more
- High-precision surface quality and flatness
- Tight tolerances and complex geometries
- Scalable production—from prototype to volume

Learn more about our [custom manufacturing capabilities](#) or submit an inquiry [here](#).

Product Details

- AR Coated to Provide <0.75% Reflection per Surface for 250 - 425nm
- Precision Fused Silica Substrate
- Various Coating Options: [Uncoated](#), [MgF₂](#), [UV-VIS](#), [VIS-EXT](#), [VIS-NIR](#), [VIS 0°](#), [YAG-BBAR](#), [NIR I](#), and [NIR II](#)

TECHSPEC® UV Fused Silica Plano-Convex (PCX) Lenses UV-AR Coated feature precision specifications and a [variety of coating options](#) on a broadband substrate. Fused Silica is commonly used in applications from the Ultraviolet (UV) through the Near-Infrared (NIR). Its low index of refraction, low coefficient of thermal expansion, and low inclusion content make it ideal for laser applications and harsh environmental conditions. TECHSPEC® UV Fused Silica Plano-Convex (PCX) Lenses UV-AR Coated feature industry-leading diameter and centration specifications, making them ideal for integration into demanding imaging and targeting applications. These lenses are UV-AR coated to increase their coating performance in the ultraviolet region.

Technical Information

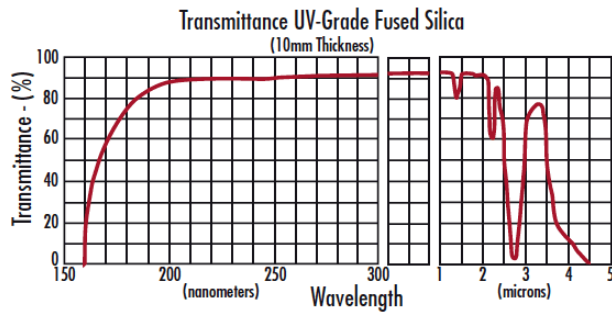

UV FS Transmission Curve

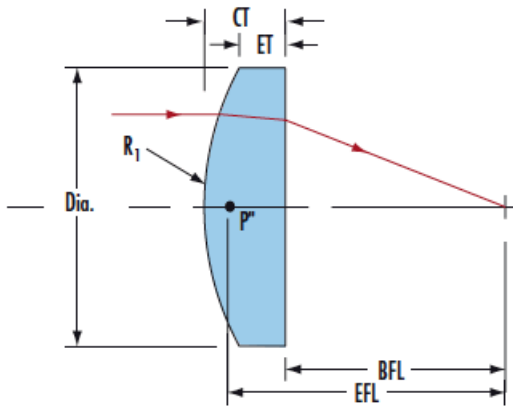

FUSED SILICA	
<h3>Uncoated Fused Silica Typical Transmission</h3> <p>The graph shows typical transmission for uncoated fused silica. The y-axis is T (%) from 70 to 100. The x-axis is Wavelength (nm) from 200 to 2200. The transmission is high (around 90-95%) across the entire range, with a small dip at approximately 1400 nm.</p>	<p>Typical transmission of a 3mm thick, uncoated fused silica window across the UV - NIR spectra.</p> <p>Click Here to Download Data</p>
<h3>Fused Silica with MgF₂ Coating Typical Transmission</h3> <p>The graph shows typical transmission for fused silica with MgF₂ coating. The y-axis is T (%) from 70 to 100. The x-axis is Wavelength (nm) from 200 to 2200. A blue shaded region indicates the coating design wavelength range from 400 nm to 700 nm. The transmission is high (around 95-98%) across the entire range, with a small dip at approximately 1400 nm.</p>	<p>Typical transmission of a 3mm thick fused silica window with MgF₂ (400-700nm) coating at 0° AOI.</p> <p>The blue shaded region indicates the coating design wavelength range, with the following specification:</p> <p>$R_{avg} \leq 1.75\% @ 400 - 700\text{nm (N-BK7)}$</p> <p>Data outside this range is not guaranteed and is for reference only.</p> <p>Click Here to Download Data</p>
<h3>Fused Silica with UV-AR Coating Typical Transmission</h3> <p>The graph shows typical transmission for fused silica with UV-AR coating. The y-axis is T (%) from 85 to 100. The x-axis is Wavelength (nm) from 200 to 2200. A blue shaded region indicates the coating design wavelength range from 250 nm to 425 nm. The transmission is high (around 95-100%) in the UV range and drops off significantly in the visible and NIR ranges.</p>	<p>Typical transmission of a 3mm thick fused silica window with UV-AR (250-425nm) coating at 0° AOI.</p> <p>The blue shaded region indicates the coating design wavelength range, with the following specification:</p> <p>$R_{abs} \leq 1.0\% @ 250 - 425\text{nm}$ $R_{avg} \leq 0.75\% @ 250 - 425\text{nm}$</p>

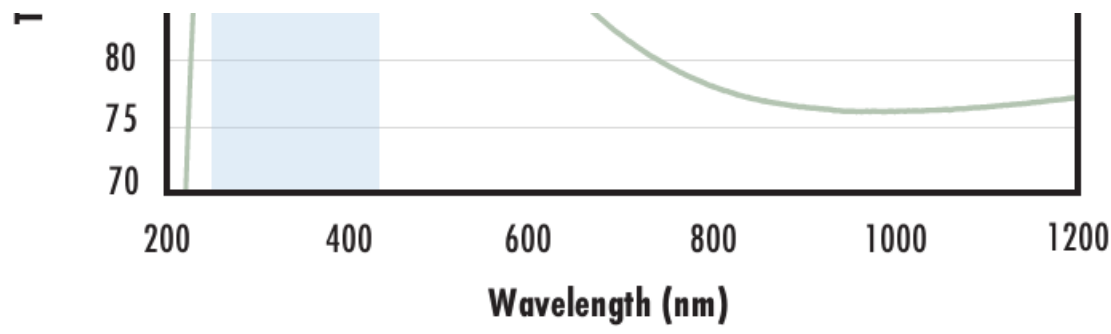

$R_{avg} \leq 0.5\%$ @ 370 - 420nm
 Data outside this range is not guaranteed and is for reference only.
[Click Here to Download Data](#)

**Fused Silica with UV-VIS Coating
 Typical Transmission**

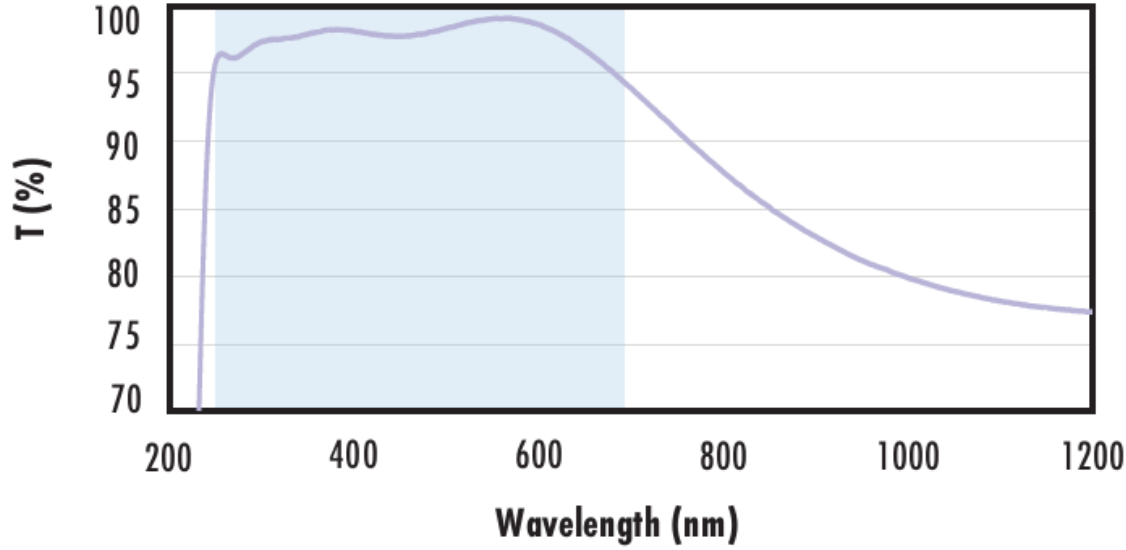

Typical transmission of a 3mm thick fused silica window with UV-VIS (250-700nm) coating at 0° AOI.
 The blue shaded region indicates the coating design wavelength range, with the following specification:
 $R_{abs} \leq 1.0\%$ @ 350 - 450nm
 $R_{avg} \leq 1.5\%$ @ 250 - 700nm
 Data outside this range is not guaranteed and is for reference only.
[Click Here to Download Data](#)

**Fused Silica with VIS-EXT Coating
 Typical Transmission**

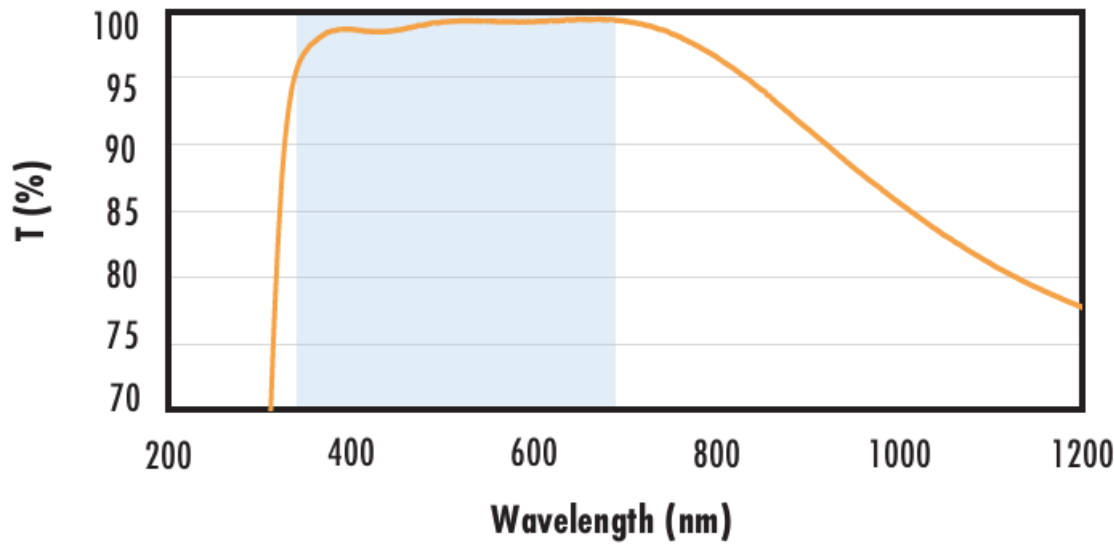

Typical transmission of a 3mm thick fused silica window with VIS-EXT (350-700nm) coating at 0° AOI.
 The blue shaded region indicates the coating design wavelength range, with the following specification:
 $R_{avg} \leq 0.5\%$ @ 350 - 700nm
 Data outside this range is not guaranteed and is for reference only.
[Click Here to Download Data](#)

**Fused Silica with VIS-NIR Coating
 Typical Transmission**

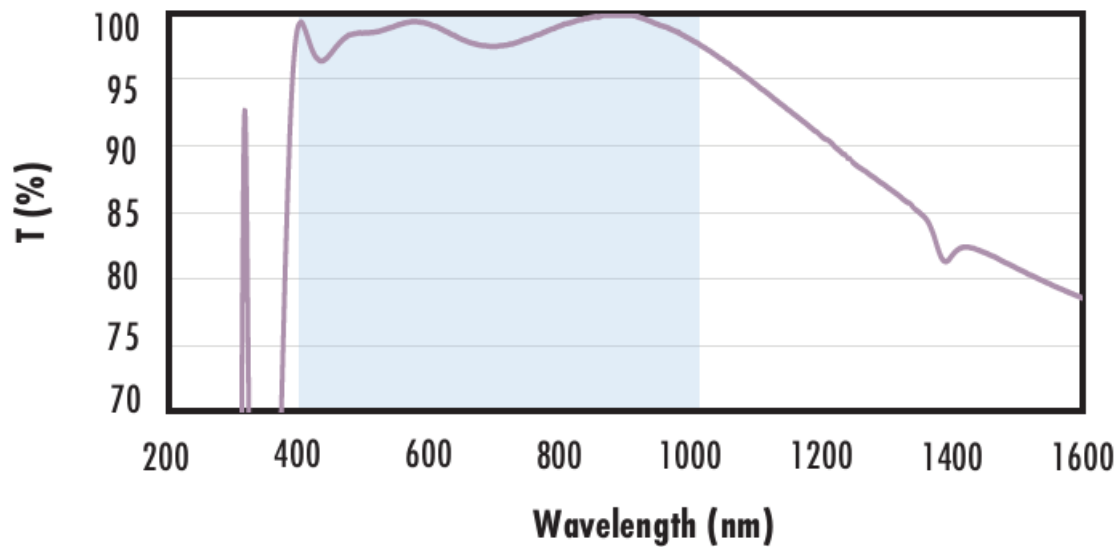

Typical transmission of a 3mm thick fused silica window with VIS-NIR (400-1000nm) coating at 0° AOI.
 The blue shaded region indicates the coating design wavelength range, with the following specification:
 $R_{abs} \leq 0.25\%$ @ 880nm
 $R_{avg} \leq 1.25\%$ @ 400 - 870nm
 $R_{avg} \leq 1.25\%$ @ 890 - 1000nm
 Data outside this range is not guaranteed and is for reference only.
[Click Here to Download Data](#)

**Fused Silica with VIS 0° Coating
 Typical Transmission**

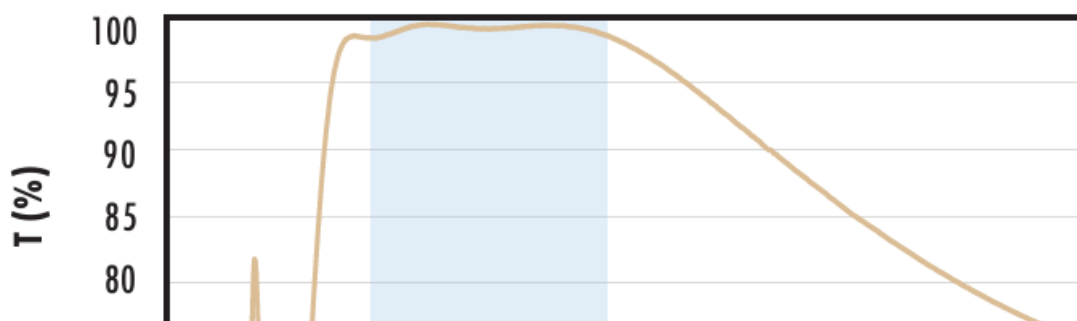

Typical transmission of a 3mm thick fused silica window with VIS 0° (425-675nm) coating at 0° AOI.
 The blue shaded region indicates the coating design wavelength range, with the following specification:
 $R_{avg} \leq 0.4\%$ @ 425 - 675nm
 Data outside this range is not guaranteed and is for reference only.
[Click Here to Download Data](#)



**Fused Silica with YAG-BBAR Coating
Typical Transmission**



Typical transmission of a 3mm thick fused silica window with YAG-BBAR (500-1100nm) coating at 0° AOI.

The blue shaded region indicates the coating design wavelength range, with the following specification:

- $R_{abs} \leq 0.25\% @ 532nm$
- $R_{abs} \leq 0.25\% @ 1064nm$
- $R_{avg} \leq 1.0\% @ 500 - 1100nm$

Data outside this range is not guaranteed and is for reference only.

[Click Here to Download Data](#)

**Fused Silica with NIR I Coating
Typical Transmission**



Typical transmission of a 3mm thick fused silica window with NIR I (600 - 1050nm) coating at 0° AOI.

The blue shaded region indicates the coating design wavelength range, with the following specification:

- $R_{avg} \leq 0.5\% @ 600 - 1050nm$

Data outside this range is not guaranteed and is for reference only.

[Click Here to Download Data](#)

**Fused Silica with NIR II Coating
Typical Transmission**



Typical transmission of a 3mm thick fused silica window with NIR II (750 - 1550nm) coating at 0° AOI.

The blue shaded region indicates the coating design wavelength range, with the following specification:

- $R_{abs} \leq 1.5\% @ 750 - 800nm$
- $R_{abs} \leq 1.0\% @ 800 - 1550nm$
- $R_{avg} \leq 0.7\% @ 750 - 1550nm$

Data outside this range is not guaranteed and is for reference only.

[Click Here to Download Data](#)

Compatible Mounts