

TECHSPEC® 35mm, f/4 Ci Series Fixed Focal Length Lens



35mm Focal Length

Stock #85-365 **14 In Stock**

⊖ 1 ⊕ C\$491⁰⁵

ADD TO CART

Volume Pricing	
Qty 1-24	C\$491.05 each
Qty 25+	C\$442.75 each
Need More?	Request Quote

Product Downloads

SPECIFICATIONS

General

Ci Series **Series:**
Fixed Focal Length Lens **Type:**

Physical & Mechanical Properties

Fixed Iris Option:

41.00 Length (mm):

26.5 Maximum Diameter (mm):

26.5 Outer Diameter (mm):

45 Weight (g):

0.18 Maximum Rear Protrusion (mm):

26.50 Diameter (mm):

Optical Properties

Horizontal Field of View @ Max Sensor Format:
22.1mm - 14.3°

Field of View at Max Sensor Format:
Horizontal: 22.1mm - 14.3°
Vertical: 16.6mm - 10.7°
Diagonal: 27.7mm - 17.8°

Horizontal Field of View, 2/3" Sensor:
22.1mm - 14.3°

Horizontal Field of View, 1/1.8" Sensor:
18.1mm - 11.7°

Horizontal Field of View, 1/2" Sensor:
16.1mm - 10.4°

Horizontal Field of View, 1/2.5" Sensor:
14.6mm - 9.4°

Horizontal Field of View, 1/3" Sensor:
12.0mm - 7.8°

Horizontal Field of View, 1/4" Sensor:
9.0mm - 5.9°

11.00 Maximum Image Circle (mm):

0.0361 Numerical Aperture NA, Object Side:

7 (6) Number of Elements (Groups):

35.00 Focal Length FL (mm):

100 - ∞ Working Distance (mm):

f/4 Aperture (f/#):

425 - 675nm BBAR Coating:

425 - 675nm BBAR Coating Specification:

21.27 Entrance Pupil Position (mm):

22.42 Object Space Principal Plane (mm):

-20.67 Image Space Principal Plane (mm):

0.17 Maximum Distortion (%):

-21.87 Exit Pupil Position (mm):

VS Lens Wavelength Range:

Sensor

2/3" Maximum Sensor Format:

2.74 Pixel Size (μm):

Threading & Mounting

M30.5 x 0.50 (Male) Filter Thread:

Filter Thread Adapter:

Front Thread:
M25.5 x 0.5 (Male)

Mount:
C-Mount

Environmental & Durability Factors

Storage Temperature (°C):
-20 to +60

Type of Ruggedization:
Industrial (Fixed Aperture with Simplified Mechanics)

Regulatory Compliance

RoHS 2015:
Compliant

REACH 201:
Compliant

Certificate of Conformance:
[View](#)

PRODUCT DETAILS

These compact lenses are designed specifically for volume integration into applications such as analytical medical devices, including benchtop-based blood analyzers. For customized f/# versions to best suit your instrumentation application needs and to discuss volume requirements, please [contact us](#).

- Up to 2/3", C-Mount Lens
- Up to 7.5 MegaPixels, 2.8µm Pixel Size Sensors
- Instrumentation (Ci) Versions of our C Series Lenses with Streamlined Mechanical Designs and Fixed Apertures
- 3.5mm to 50mm Focal Length
- [Ruggedized \(Cr\) Designs](#) Also Available

TECHSPEC® Ci Series Fixed Focal Length Lenses are a streamlined version of our C Series Fixed Focal Length Lenses. They feature the same low lens-to-lens variation and broadband anti-reflection (BBAR) coating for maximum light transmission, while offering reduced weight and size. An adjustable, lockable focus allows for setting and locking the best focus position for instrumentation integration. TECHSPEC® Ci Series Fixed Focal Length Lenses are designed specifically for volume integration into applications such as factory inspection and automation to benchtop biomedical devices. The Ci Series offers a wide range of aperture options, ensuring maximum flexibility of resolution, throughput, and depth of field.

Edmund Optics has created a family of high performance optical designs (the C Series family) and developed 6 customized optomechanical solutions targeted for specific applications. These lens sub-families utilize the same optics as the C Series lenses providing the same optical performance in a variety of optomechanical solutions to meet your application requirements:

- **C Series:** Features locking cam focus and iris adjustment and is the most adjustable version of these optical designs; they are the typical high quality machine vision lenses. Also available with a [VIS-NIR Broadband Anti-Reflection \(BBAR\) Coating](#).
- **Ci Series:** Simplified mechanics featuring fixed apertures with compact housing. [Industrial Ruggedization](#) for reduced size, cost, and locked focus.
- **Cr Series:** All optics glued in place and a locking C-clamp focus ring. [Stabilized Ruggedization](#) for reduced pixel shift and improved focus stability.
- **Cx Series:** Modular, flexible mechanics allows lenses to be taken apart for easy integration of accessories such as liquid lenses, apertures, and more.
- **Liquid Lens Cx Series:** Designed with an integrated liquid lens for quick autofocus.
- **Cw Series:** Waterproof, designed to meet IEC [Ingress Protection](#) Code IPX7 and IPX9K.

TECHNICAL INFORMATION

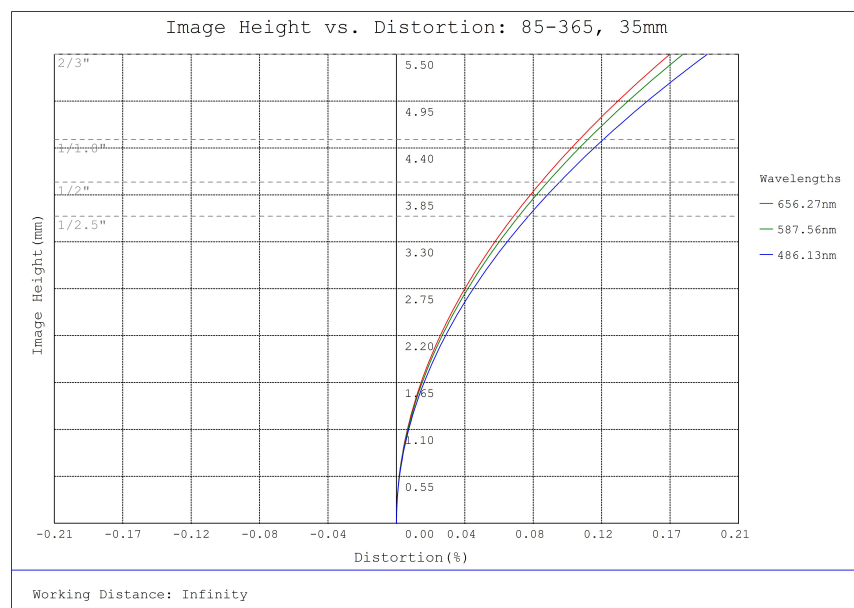

#85-365, 35mm, f/4 Ci Series Fixed Focal Length Lens, Distortion Plot

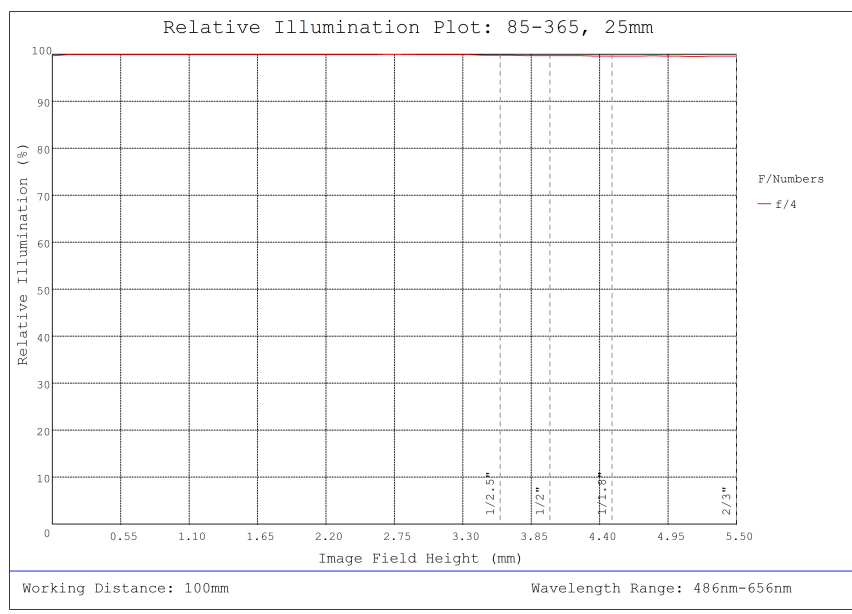

#85-365, 35mm, f/4 Ci Series Fixed Focal Length Lens, Relative Illumination Plot

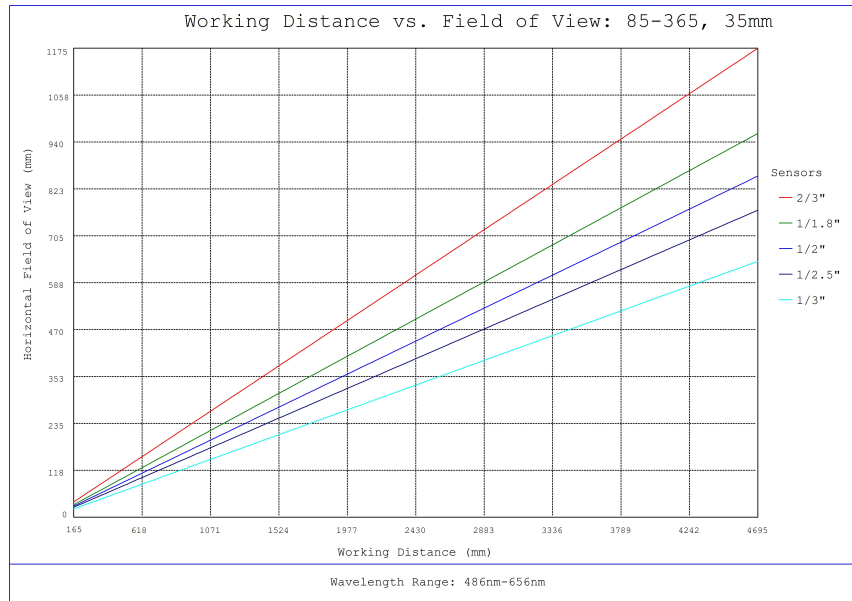

#85-365, 35mm, f/4 Ci Series Fixed Focal Length Lens, Working Distance versus Field of View Plot

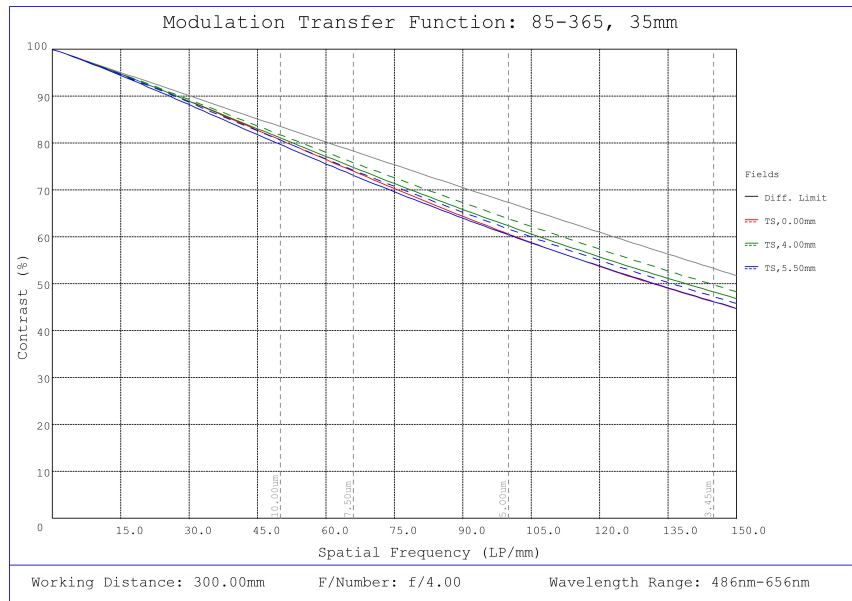

#85-365, 35mm, f/4 Ci Series Fixed Focal Length Lens, Modulated Transfer Function (MTF) Plot, 300mm Working Distance, f4

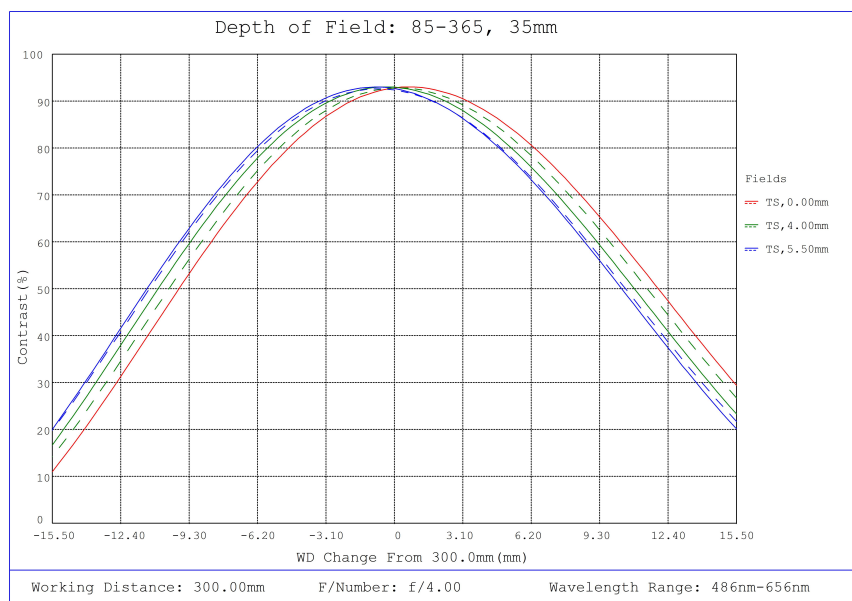

#85-365, 35mm, f/4 Ci Series Fixed Focal Length Lens, Depth of Field Plot, 300mm Working Distance, f4

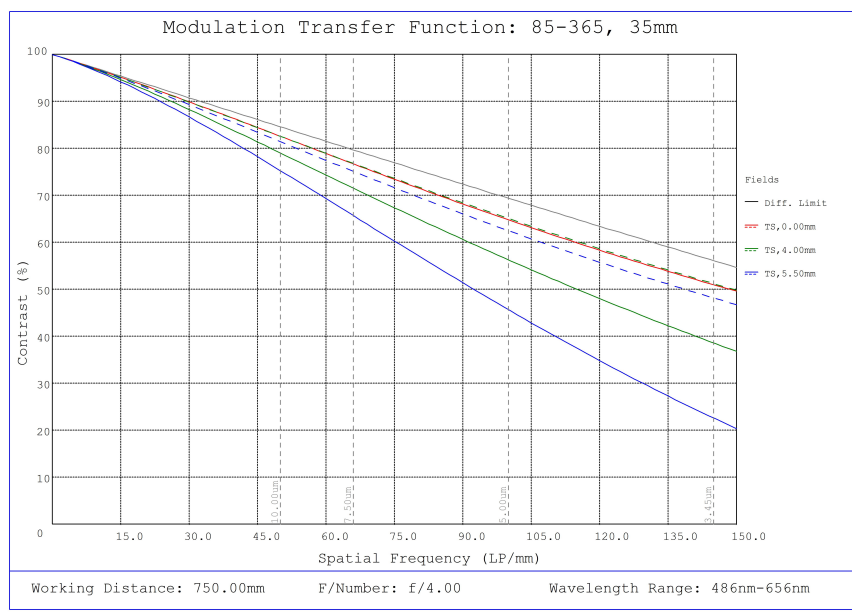

#85-365, 35mm, f/4 Ci Series Fixed Focal Length Lens, Modulated Transfer Function (MTF) Plot, 750mm Working Distance, f4



#85-365, 35mm, f/4 Ci Series Fixed Focal Length Lens, Depth of Field Plot, 750mm Working Distance, f4

Focal Length	A	B	C	D
6mm	M3.0 x 0.5	47.8mm	34mm	1.17mm
12mm	M2.0 x 0.75	29.0mm	22mm	0.96mm
16mm	M2.0 x 0.75	40.8mm	22mm	1.09mm
25mm	M2.0 x 0.75	29.9mm	22mm	1.33mm
35mm	M2.5 x 0.5	41mm	22.5mm	3.82mm
50mm	M3.0 x 0.5	49.5mm	30.5mm	2.06mm

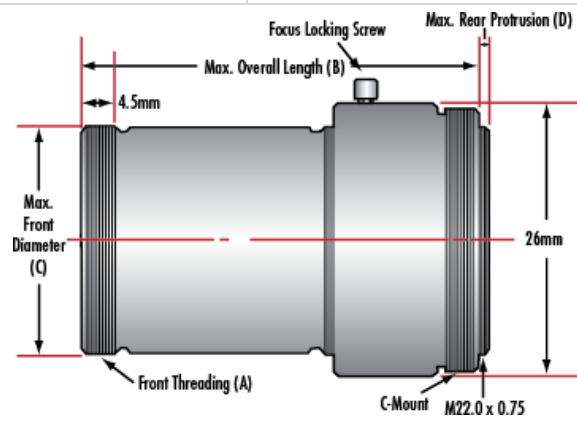

COMPATIBLE CAMERAS