

**TECHSPEC® 3mm FL f/8.0, IR-Cut Blue Series M12 Lens**



3mm FL Blue Series M12 Lens



Stock #20-058 **20+ In Stock**

⊖ 1 ⊕ C\$161<sup>00</sup>

**ADD TO CART**

Volume Pricing	
Qty 1-49	C\$161.00 each
Qty 50+	C\$127.40 each
Need More?	<a href="#">Request Quote</a>

Product Downloads

**General**

Blue Series **Product Family:**

M12 Imaging Lens **Type:**

Yes **IR Cut Filter:**

**Imaging Lens Type:**  
High Performance M12 Lens with IR Cut Filter

**Special Type of Lens:**  
IR-Cut Filter

## Physical & Mechanical Properties

**Iris Option:**  
Fixed

**Length (mm):**  
16.10

**Maximum Diameter (mm):**  
14

**Outer Diameter (mm):**  
14

## Optical Properties

**Horizontal Field of View @ Max Sensor Format:**  
91.3°

**Field of View at Max Sensor Format:**  
Horizontal: 91.2°  
Vertical: 68.5°  
Diagonal: 113°

**Horizontal Field of View, 1/3" Sensor:**  
91.2°

**Maximum Image Circle (mm):**  
6.00

**Numerical Aperture NA, Object Side:**  
0.002

**Number of Elements (Groups):**  
6(5)

**Wavelength Range (nm):**  
400 - 700

**Focal Length FL (mm):**  
3.00

**Working Distance (mm):**  
100 - ∞

**Aperture (f/#):**  
f/8

**Distortion (%):**  
-34.8 @ Full Field

**Back Focal Length BFL (mm):**  
4.8 - 4.7

**Coating Specification:**  
M4 MgF<sub>2</sub> @ 550nm

**Entrance Pupil Position (mm):**  
4.90

**Object Space Principal Plane (mm):**  
-6.55

**Image Space Principal Plane (mm):**  
2.46

**Maximum Distortion (%):**  
-34.8

**Exit Pupil Position (mm):**  
-3.23

**Lens Wavelength Range:**  
VIS (IR-Cut Filter)

## Sensor

**Maximum Sensor Format:**  
1/3"

**Pixel Size (µm):**  
1.40

## Threading & Mounting

**Filter Thread:**  
N/A

**Mount:**  
S-Mount (M12 x0.5)

## Regulatory Compliance

**RoHS 2015:**  
[Compliant](#)

**Certificate of Conformance:**  
[View](#)

## Product Details

- Up to 1/2", S-Mount Lens
- Up to 5 MegaPixels, 1.4µm Pixel Size Sensors
- High Resolution Board Camera Lens Optimized for Close WD
- 2mm to 35mm Focal Length
- **Ruggedized Designs** Also Available

TECHSPEC® Blue Series M12 Lenses feature high resolution performance, along with the same great versatility of our **TECHSPEC® Green Series M12 Lenses**. Each lens consists of several precision glass elements mounted in a compact, aluminum housing. These lenses can connect to C-Mount cameras using the M12 x0.5 Adapter for C-Mount Cameras (**#53-675**) or the M12 x0.5 C-Mount Adapter with Rubber O-Ring (**#59-241**) for vibration-sensitive environments. TECHSPEC® Blue Series M12 Lenses are ideal for automotive, industrial, and medical imaging application. Prescription data is available by submitting a [Request for Prescription Form](#).

**Note:** Compatible **TECHSPEC® M12 Imaging Lens Accessories** available.

Edmund Optics has created multiple product families of our TECHSPEC® M12 S-Mount Lenses, which are designed to provide high resolution. These high performance lenses feature precision glass designs in a metal housing and have optimized specifications between each product family to meet your application needs.

- **Blue Series M12 Lenses:** High resolution finite conjugate designs optimized for machine vision working distances.
- **Rugged Blue Series M12 Lenses:** Stabilized ruggedization versions of our Blue Series M12 Lenses, utilizing the same optics.
- **Green Series M12 Lenses:** Finite conjugate designs optimized for machine vision working distances.
- **Red Series M12 Lenses:** Infinite conjugate designs optimized for high resolution performance out to infinity.
- **HEO Series M12 Lenses:** Harsh Environment Optics (HEO) sealed versions of our Red Series M12 Lenses.
- **Liquid Lens M12 Lenses:** Integrated liquid lens for fast electronic focus.

## Technical Information

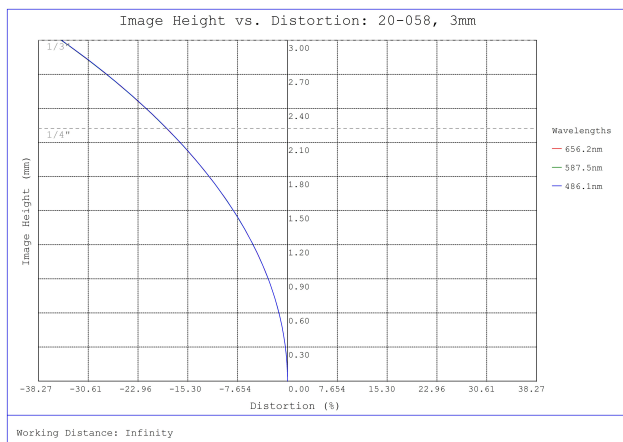

#20-058, 3mm FL f/8.0, IR-Cut Blue Series M12 Lens, Distortion Plot

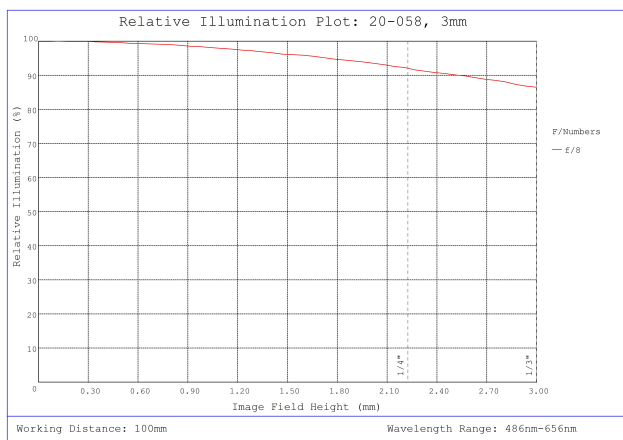

#20-058, 3mm FL f/8.0, IR-Cut Blue Series M12 Lens, Relative Illumination Plot

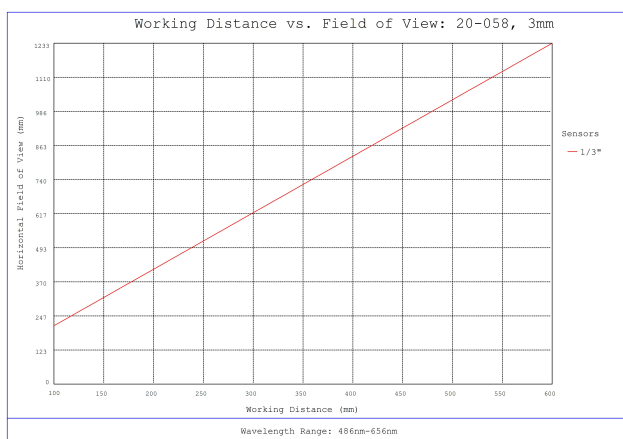

#20-058, 3mm FL f/8.0, IR-Cut Blue Series M12 Lens, Working Distance versus Field of View Plot

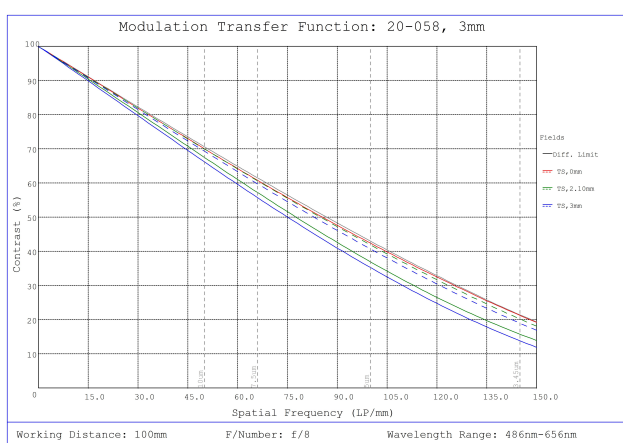

#20-058, 3mm FL f/8.0, IR-Cut Blue Series M12 Lens, Modulated Transfer Function (MTF) Plot, 100mm Working Distance, f8

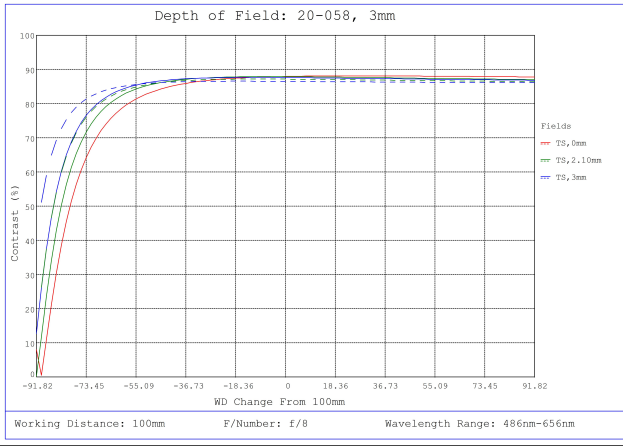

#20-058, 3mm FL f/8.0, IR-Cut Blue Series M12 Lens, Depth of Field Plot, 100mm Working Distance, f8

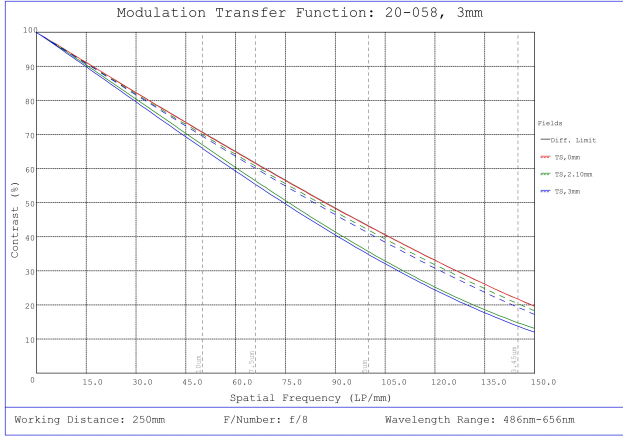

#20-058, 3mm FL f/8.0, IR-Cut Blue Series M12 Lens, Modulated Transfer Function (MTF) Plot, 250mm Working Distance, f8

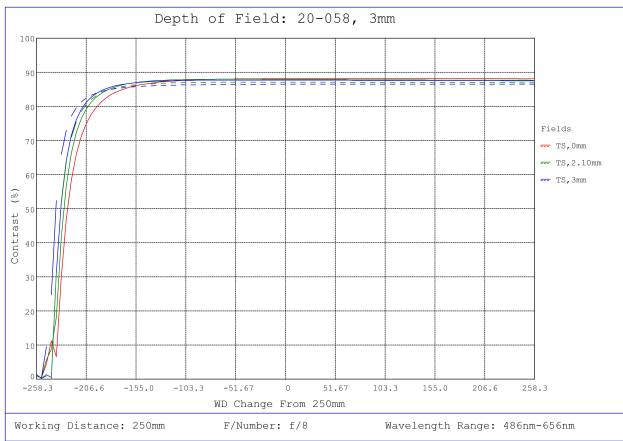

#20-058, 3mm FL f/8.0, IR-Cut Blue Series M12 Lens, Depth of Field Plot, 250mm Working Distance, f8

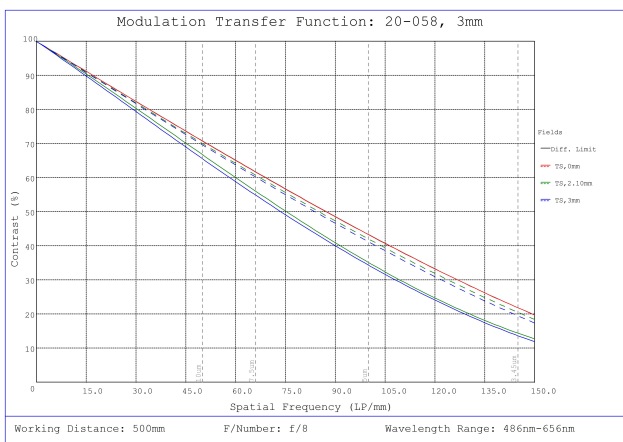

#20-058, 3mm FL f/8.0, IR-Cut Blue Series M12 Lens, Modulated Transfer Function (MTF) Plot, 500mm Working Distance, f8

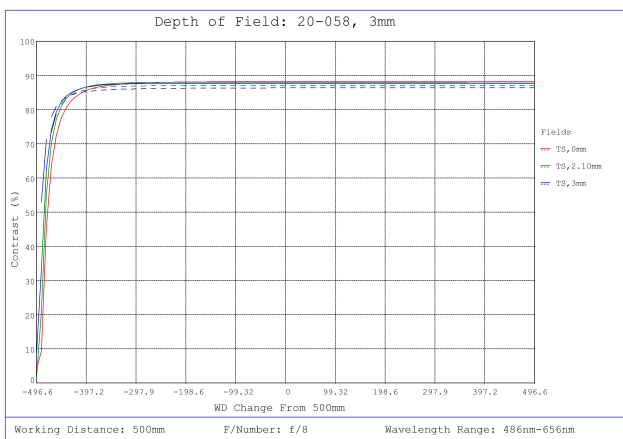

#20-058, 3mm FL f/8.0, IR-Cut Blue Series M12 Lens, Depth of Field Plot, 500mm Working Distance, f8

Focal Length	A	B	C*	D
2.0mm	18.0mm	21.7mm	2.26mm	4.75mm

3.0mm	14.0mm	17.1mm	4.8 - 4.7mm	5.8mm
4.0mm	14.0mm	19.7mm	6.1 - 6.0mm	4.4mm
5.0mm	14.0mm	14.6mm	4.0 - 3.9mm	3.7mm
6.0mm	14.0mm	14.1mm	6.9 - 6.8mm	4.5mm
8.0mm	14.0mm	12.3mm	8.8 - 8.6mm	3.7mm
10.0mm	14.0mm	17.0mm	6.6 - 6.3mm	3.7mm
12.5mm	15.0mm	22.9mm	10.1 - 9.7mm	4.8mm
17.5mm	14.0mm	20.7mm	5.8 - 4.9mm	7.6mm
25.0mm	18.0mm	30.0mm	8.5 - 6.5mm	11.5mm
35.0mm	18.0mm	29.5mm	18.72 - 14.0mm	14.5mm

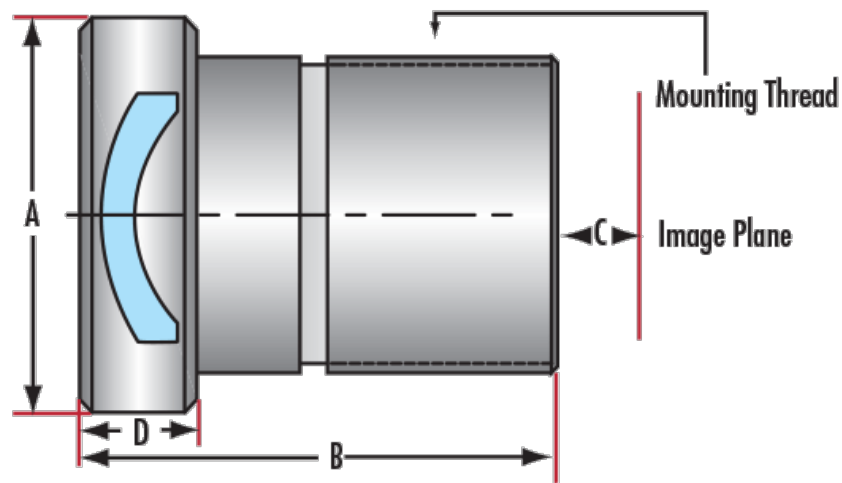

\*Specified for Optimized Working Distance of 150 - 250mm.