

[See all 413 Products in Family](#)

TECHSPEC® 6.0mm Dia. x 9.0mm FL, VIS-NIR Coated, Plano-Convex Lens

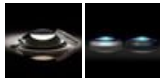

Stock **#45-466** **20+ In Stock**

[Other Coating Options](#)

1 C\$64^{.75}

ADD TO CART

Volume Pricing	
Qty 1-9	C\$64.75 each
Qty 10-24	C\$58.10 each
Qty 25-49	C\$52.15 each
Need More?	Request Quote

Product Downloads

General

Plano-Convex Lens **Type:**

Physical & Mechanical Properties

6.00 +0.0/-0.025 **Diameter (mm):**

<3	Centering (arcmin):
1.75 ±0.05	Center Thickness CT (mm):
0.95	Edge Thickness ET (mm):
5.4	Clear Aperture CA (mm):
Protective as needed	Bevel:
Optical Properties	
9.00 @ 587.6nm	Effective Focal Length EFL (mm):
7.95	Back Focal Length BFL (mm):
VIS-NIR (400-1000nm)	Coating:
R _{abs} ≤0.25% @ 880nm R _{avg} ≤1.25% @ 400 - 870nm R _{avg} ≤1.25% @ 890 - 1000nm	Coating Specification:
N-SF5	Substrate: <input type="checkbox"/>
40-20	Surface Quality:
1.5λ	Power (P-V) @ 632.8nm:
λ/4	Irregularity (P-V) @ 632.8nm:
±1	Focal Length Tolerance (%):
6.05	Radius R₁ (mm):
1.5	f#:
0.33	Numerical Aperture NA:
400 - 1000	Wavelength Range (nm):
5 J/cm ² @ 532nm, 10ns	Damage Threshold, By Design: <input type="checkbox"/>

Regulatory Compliance	
Compliant	RoHS 2015:
View	Certificate of Conformance:
Compliant	Reach 240:

Need different specs or modifications?

Edmund Optics offers comprehensive custom manufacturing services for optical and imaging components tailored to your specific application requirements. Whether in the prototyping phase or preparing for full-scale production, we provide flexible solutions to meet your needs. Our experienced engineers are here to assist—from concept to completion.

Our capabilities include:

- Custom dimensions, materials, coatings, and more
- High-precision surface quality and flatness
- Tight tolerances and complex geometries
- Scalable production—from prototype to volume

Learn more about our [custom manufacturing capabilities](#) or submit an inquiry [here](#).

Product Details

- AR Coated to Provide <1.25% Reflectance per Surface for 400 - 1000nm
- <0.25% Reflectance @ 880nm
- Designed for 0° Angle of Incidence
- Various PCX Coating Options: [Uncoated](#), [MgF₂](#), [VIS 0°](#), [NIR I](#), [NIR II](#), [VIS-EXT](#), and [YAG-BBAR](#)

TECHSPEC® VIS-NIR Coated Plano-Convex (PCX) Lenses have a positive focal length, making them ideal for collecting and focusing light in imaging applications. They are also useful in a variety of applications involving emitters, detectors, lasers, and fiber optics. Plano-Convex lenses are ideal for a multitude of optics and photonics applications, including biotech instruments such as DNA sequencers and polymerase chain reaction (PCR) testing platforms. TECHSPEC® VIS-NIR Coated Plano-Convex (PCX) Lenses are available in a wide variety of diameters and focal lengths. Identical designs of these PCX lenses are also offered [uncoated](#) or with broadband anti-reflective (BBAR) coatings, which include [MgF₂](#), [VIS 0°](#), [NIR I](#), [NIR II](#), [VIS-EXT](#), and [YAG-BBAR](#).

These coated lenses are optimized for a wide range of optics and photonics applications, including biotech instruments such as DNA sequencers and polymerase chain reaction (PCR) testing platforms.

Technical Information

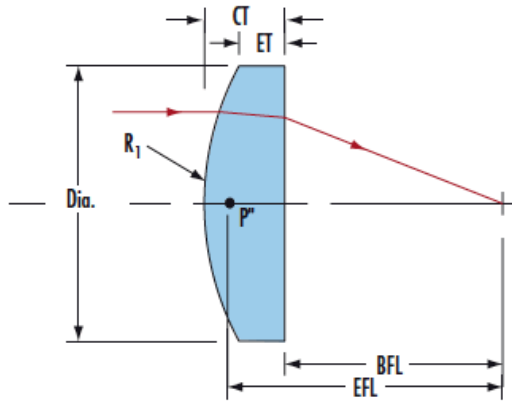
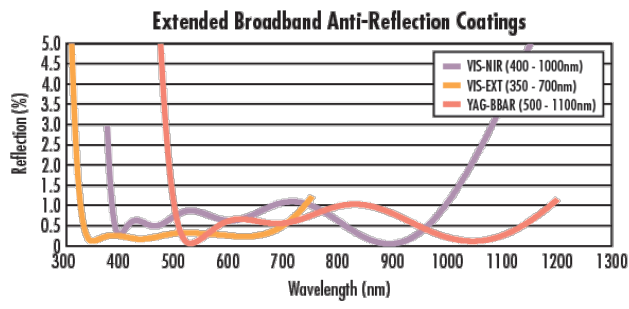

N-BK7

Uncoated N-BK7 Typical Transmission

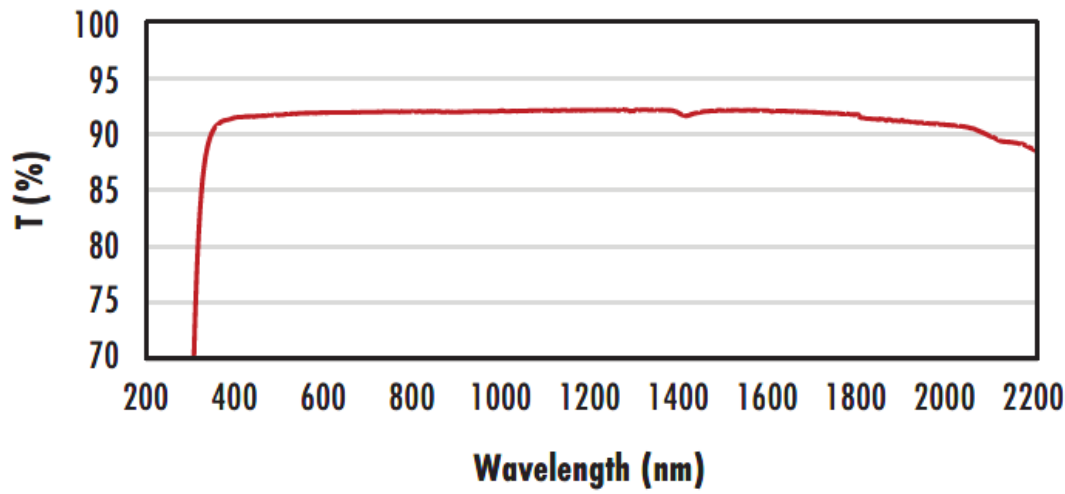

Typical transmission of a 3mm thick, uncoated N-BK7 window across the UV - NIR spectra.

[Click Here to Download Data](#)

N-BK7 with MgF₂ Coating Typical Transmission

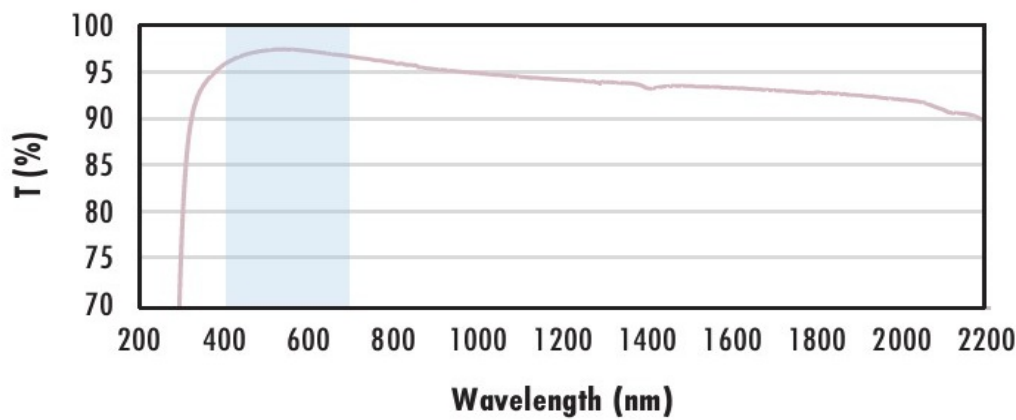

Typical transmission of a 3mm thick N-BK7 window with MgF₂ (400-700nm) coating at 0° AOI.

The blue shaded region indicates the coating design wavelength range, with the following specification:

$$R_{avg} \leq 1.75\% @ 400 - 700\text{nm (N-BK7)}$$

Data outside this range is not guaranteed and is for reference only.

[Click Here to Download Data](#)

N-BK7 with VIS-EXT Coating Typical Transmission

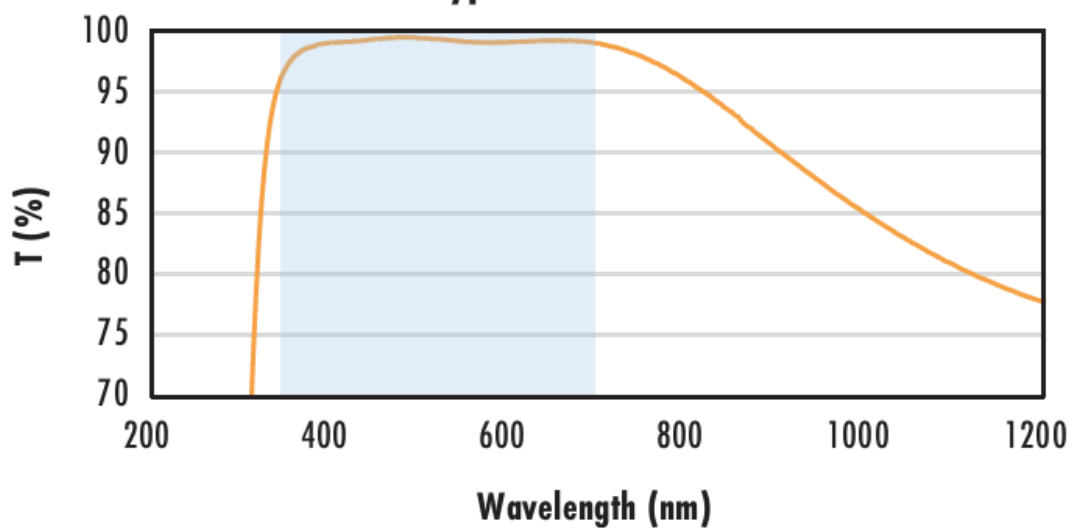

Typical transmission of a 3mm thick N-BK7 window with VIS-EXT (350-700nm) coating at 0° AOI.

The blue shaded region indicates the coating design wavelength range, with the following specification:

$$R_{avg} \leq 0.5\% @ 350 - 700\text{nm}$$

Data outside this range is not guaranteed and is for reference only.

[Click Here to Download Data](#)

N-BK7 with VIS-NIR Coating

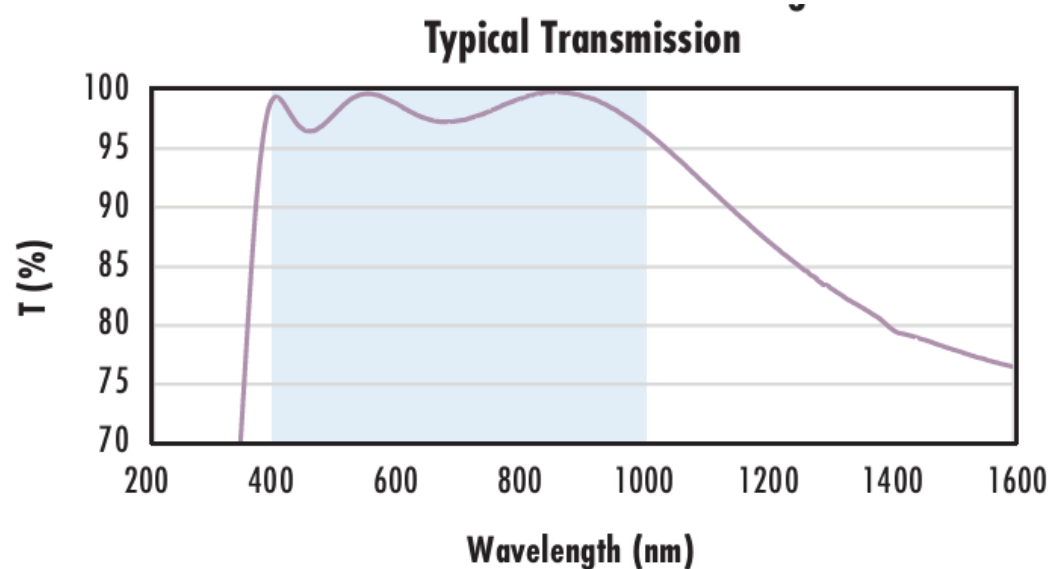

Typical transmission of a 3mm thick N-BK7 window with VIS-NIR (400-1000nm) coating at 0° AOI.

The blue shaded region indicates the coating design wavelength range, with the following specification:

$$R_{abs} \leq 0.25\% @ 880\text{nm}$$

$$R_{avg} \leq 1.25\% @ 400 - 870\text{nm}$$

$$R_{avg} \leq 1.25\% @ 890 - 1000\text{nm}$$

Data outside this range is not guaranteed and is for reference only.

[Click Here to Download Data](#)

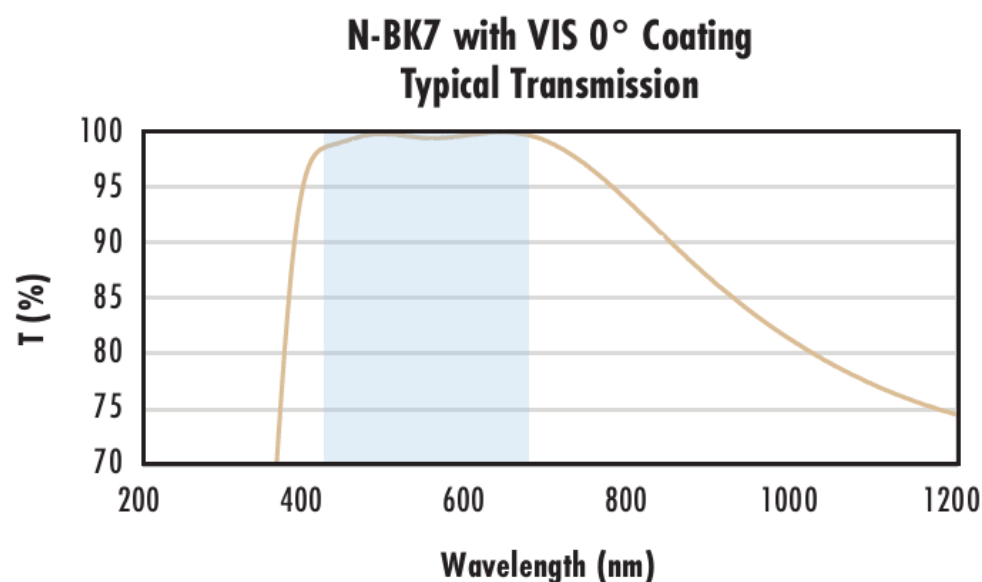

Typical transmission of a 3mm thick N-BK7 window with VIS 0° (425-675nm) coating at 0° AOI.

The blue shaded region indicates the coating design wavelength range, with the following specification:

$$R_{avg} \leq 0.4\% @ 425 - 675\text{nm}$$

Data outside this range is not guaranteed and is for reference only.

[Click Here to Download Data](#)

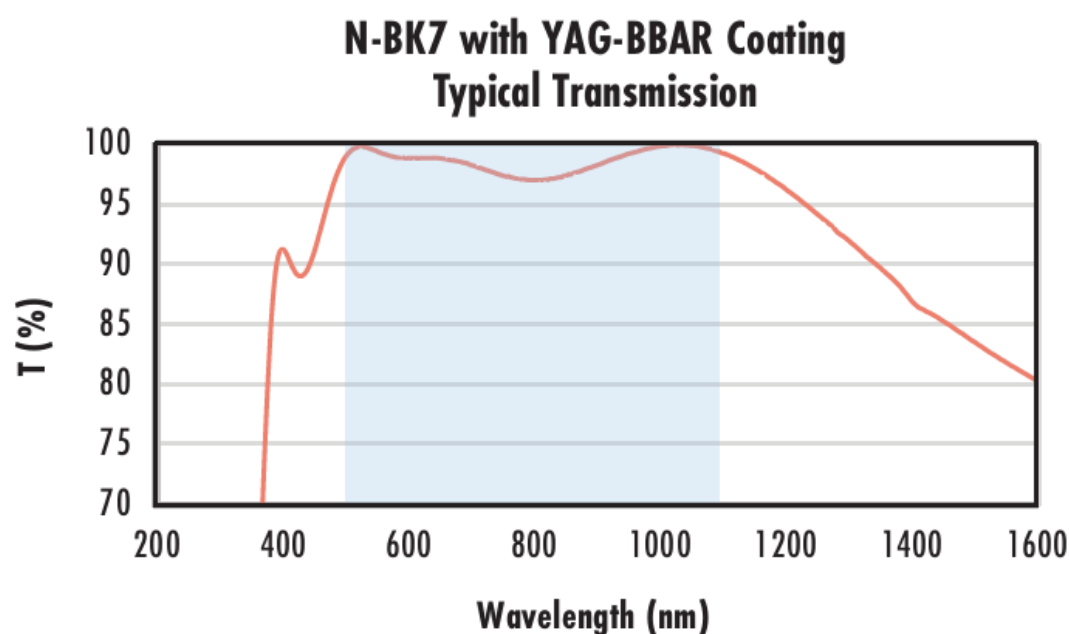

Typical transmission of a 3mm thick N-BK7 window with YAG-BBAR (500-1100nm) coating at 0° AOI.

The blue shaded region indicates the coating design wavelength range, with the following specification:

$$R_{abs} \leq 0.25\% @ 532\text{nm}$$

$$R_{abs} \leq 0.25\% @ 1064\text{nm}$$

$$R_{avg} \leq 1.0\% @ 500 - 1100\text{nm}$$

Data outside this range is not guaranteed and is for reference only.

[Click Here to Download Data](#)

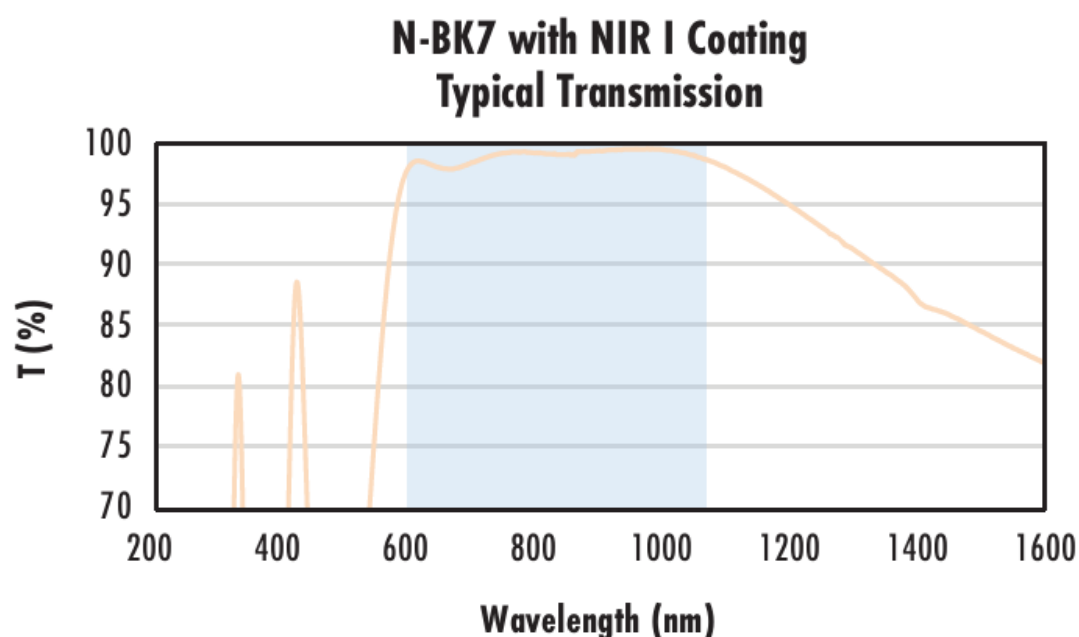

Typical transmission of a 3mm thick N-BK7 window with NIR I (600 - 1050nm) coating at 0° AOI.

The blue shaded region indicates the coating design wavelength range, with the following specification:

$$R_{avg} \leq 0.5\% @ 600 - 1050\text{nm}$$

Data outside this range is not guaranteed and is for reference only.

[Click Here to Download Data](#)

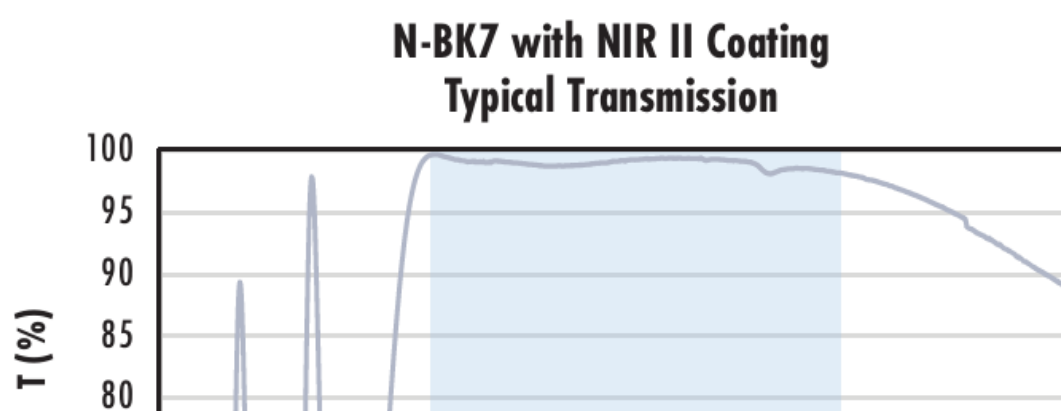

Typical transmission of a 3mm thick N-BK7 window with NIR II (750 - 1550nm) coating at 0° AOI.

The blue shaded region indicates the coating design wavelength range, with the following specification:

$$R_{abs} \leq 1.5\% @ 750 - 800\text{nm}$$

$$R_{abs} \leq 1.0\% @ 800 - 1550\text{nm}$$

$$R_{avg} \leq 0.7\% @ 750 - 1550\text{nm}$$

Data outside this range is not guaranteed and is for reference only.

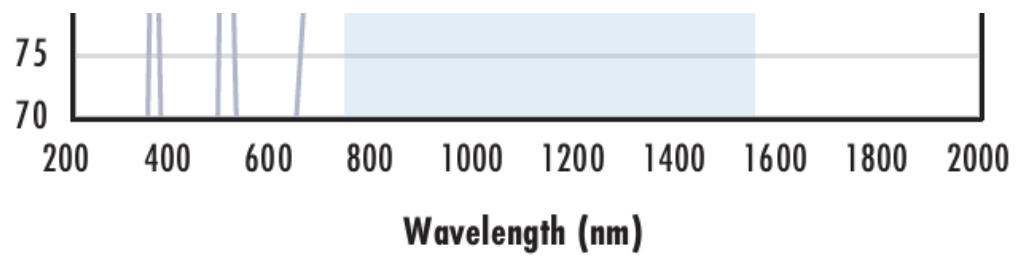

Data outside this range is not guaranteed and is for reference only.

[Click Here to Download Data](#)

Coating Curves

Compatible Mounts