

TECHSPEC® 6° Beam Dev. 12.5mm Dia. VIS 0°, N-BK7 Wedge Prism



Stock #35-789 **1 In Stock**

⊖ 1 ⊕ C\$76³⁰

ADD TO CART

Volume Pricing	
Qty 1-5	C\$76.30 each
Qty 6-25	C\$61.25 each
Qty 26-49	C\$57.05 each
Need More?	Request Quote

Product Downloads

General

Wedge Prism

Type:

Note:
Specify this is S1 & S2 power and irregularity, not the overall power of the wedge

Physical & Mechanical Properties

12.50 +0.00/-0.10

Diameter (mm):

1.50	Thickness (mm):
Protective as needed	Bevel:
11° 21'	Wedge Angle (arcmin):
Optical Properties	
±30	Angle Tolerance (arcsec):
VS 0° (425-675nm)	Coating:
632.8	Design Wavelength DWL (nm):
N-BK7	Substrate: <input type="checkbox"/>
20-10	Surface Quality:
Beam Deviation	Image Orientation:
$R_{avg} \leq 0.4\%$ @ 425 - 675nm	Coating Specification:
425 - 675	Wavelength Range (nm):
0.50	Power (fringes) @ 632.8nm:
0.20	Irregularity (fringes) @ 632.8nm:
6.00	Ray Deviation @ 633nm (°):
10.51	Power (diopters):
11.35°	Wedge Angle (°):

Material Properties	
7.1	Coefficient of Thermal Expansion CTE (10⁻⁶/°C):

Regulatory Compliance	
Compliant	RoHS 2015:
View	Certificate of Conformance:
Compliant	Reach 235:

Need different specs or modifications?

Edmund Optics offers comprehensive custom manufacturing services for optical and imaging components tailored to your specific application requirements. Whether in the prototyping phase or preparing for full-scale production, we provide flexible solutions to meet your needs. Our experienced engineers are here to assist—from concept to completion.

Our capabilities include:

- Custom dimensions, materials, coatings, and more
- High-precision surface quality and flatness
- Tight tolerances and complex geometries
- Scalable production—from prototype to volume

Learn more about our [custom manufacturing capabilities](#) or submit an inquiry [here](#).

Product Details

- Ideal for Beam Steering
- 0.5° - 15° Beam Deviation Options
- Available Uncoated or Anti-Reflection Coated
- **Anamorphic Prism Pair** Also Available

Wedge prisms can be used individually to deviate a laser beam a set angle, or two wedge prisms can be used together for beam steering applications. A single wedge prism's ability to deviate the angle of an incident beam is measured in Diopters with 1 diopter deviating the beam 1cm at a 1m working distance.

Two wedge prisms can be used as an anamorphic pair for beam shaping (to correct the elliptical shape of diode outputs). Wedge prisms can also be paired to steer a beam anywhere within a circle described by the full angle 4θ , where θ is the deviation from a single prism. This beam steering is accomplished by rotating the two wedge prisms independently of each other and is typically used to scan a beam to different locations in imaging applications.

Note: Beam deviation is shown in degrees and diopters. One diopter is 1cm of deviation at a distance of 1m from the prism.

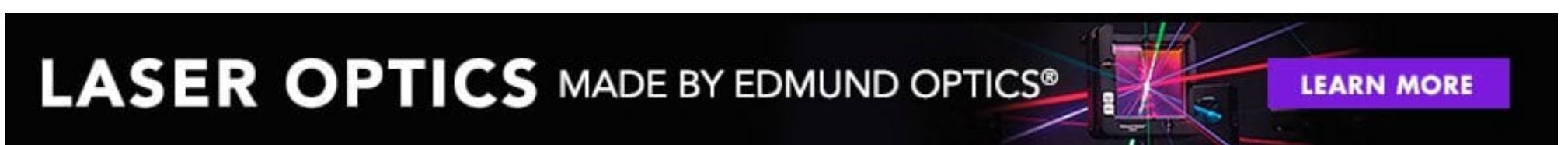

Technical Information

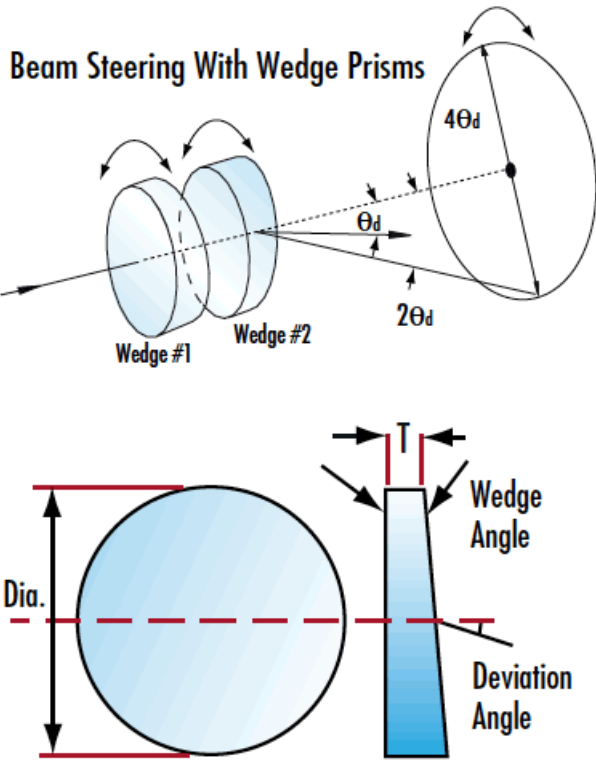

N-BK7

Uncoated N-BK7 Typical Transmission



Typical transmission of a 3mm thick, uncoated N-BK7 window across the UV- NIR spectra.

[Click Here to Download Data](#)

N-BK7 with MgF₂ Coating Typical Transmission

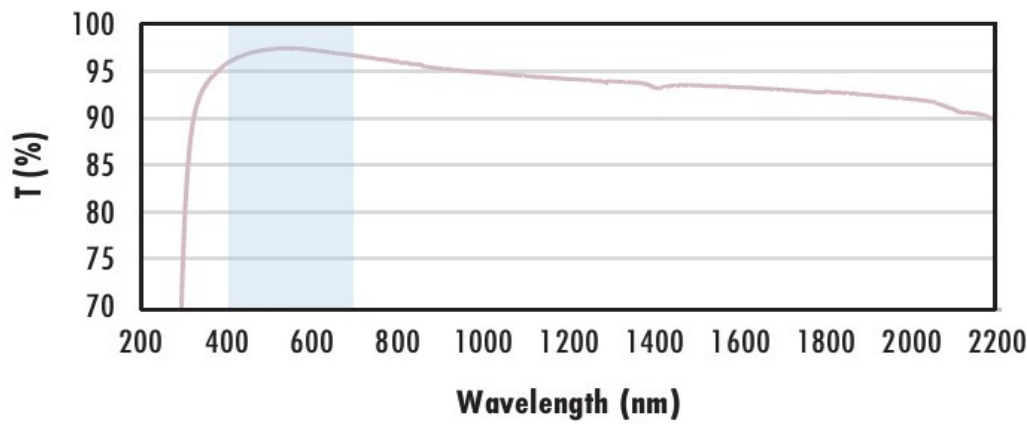

Typical transmission of a 3mm thick N-BK7 window with MgF₂ (400-700nm) coating at 0° AOI.

The blue shaded region indicates the coating design wavelength range, with the following specification:

$$R_{avg} \leq 1.75\% @ 400 - 700\text{nm (N-BK7)}$$

Data outside this range is not guaranteed and is for reference only.

[Click Here to Download Data](#)

N-BK7 with VIS-EXT Coating Typical Transmission

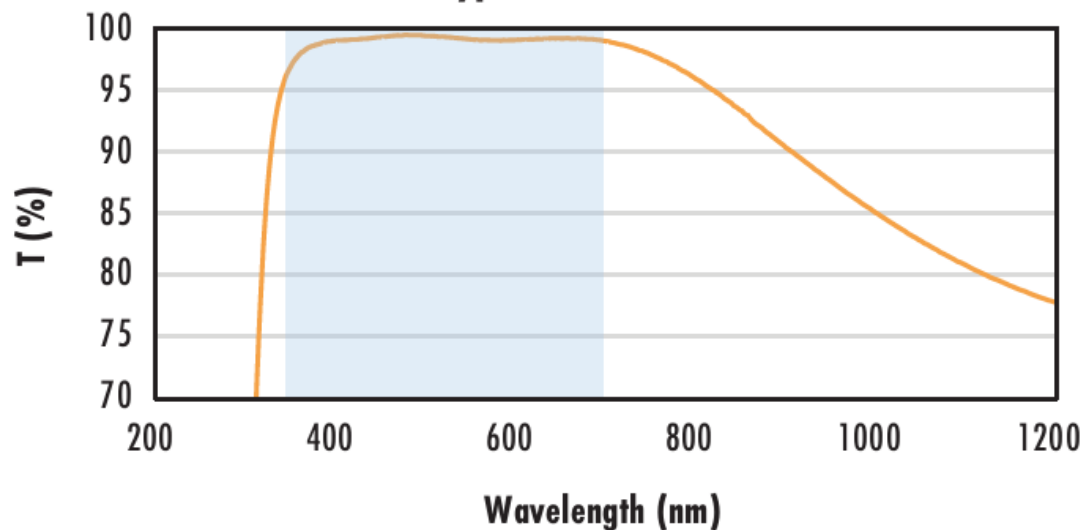

Typical transmission of a 3mm thick N-BK7 window with VIS-EXT (350-700nm) coating at 0° AOI.

The blue shaded region indicates the coating design wavelength range, with the following specification:

$$R_{avg} \leq 0.5\% @ 350 - 700\text{nm}$$

Data outside this range is not guaranteed and is for reference only.

[Click Here to Download Data](#)

N-BK7 with VIS-NIR Coating Typical Transmission



Typical transmission of a 3mm thick N-BK7 window with VIS-NIR (400-1000nm) coating at 0° AOI.

The blue shaded region indicates the coating design wavelength range, with the following specification:

$$R_{abs} \leq 0.25\% @ 880\text{nm}$$

$$R_{avg} \leq 1.25\% @ 400 - 870\text{nm}$$

$$R_{avg} \leq 1.25\% @ 890 - 1000\text{nm}$$

Data outside this range is not guaranteed and is for reference only.

[Click Here to Download Data](#)

N-BK7 with VIS 0° Coating Typical Transmission

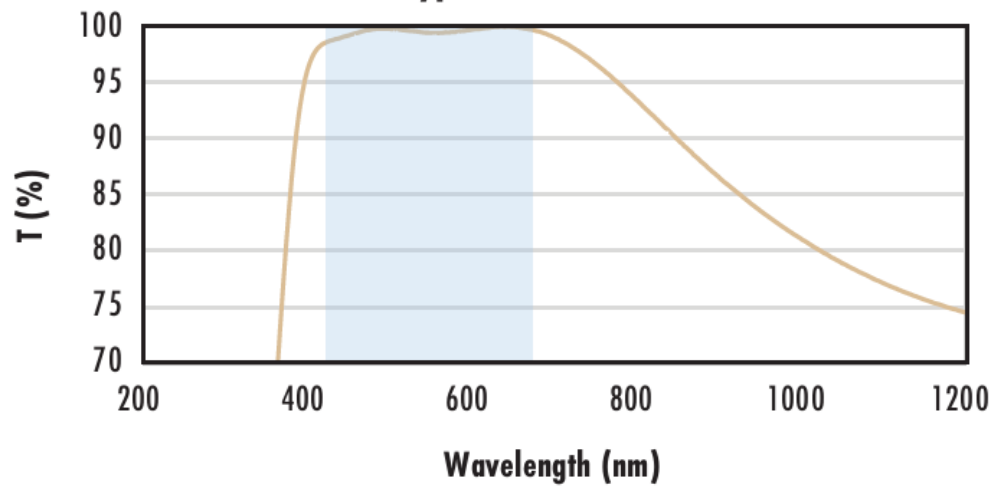

Typical transmission of a 3mm thick N-BK7 window with VIS 0° (425-675nm) coating at 0° AOI.

The blue shaded region indicates the coating design wavelength range, with the following specification:

$$R_{avg} \leq 0.4\% @ 425 - 675\text{nm}$$

Data outside this range is not guaranteed and is for reference only.

[Click Here to Download Data](#)

N-BK7 with YAG-BBAR Coating Typical Transmission

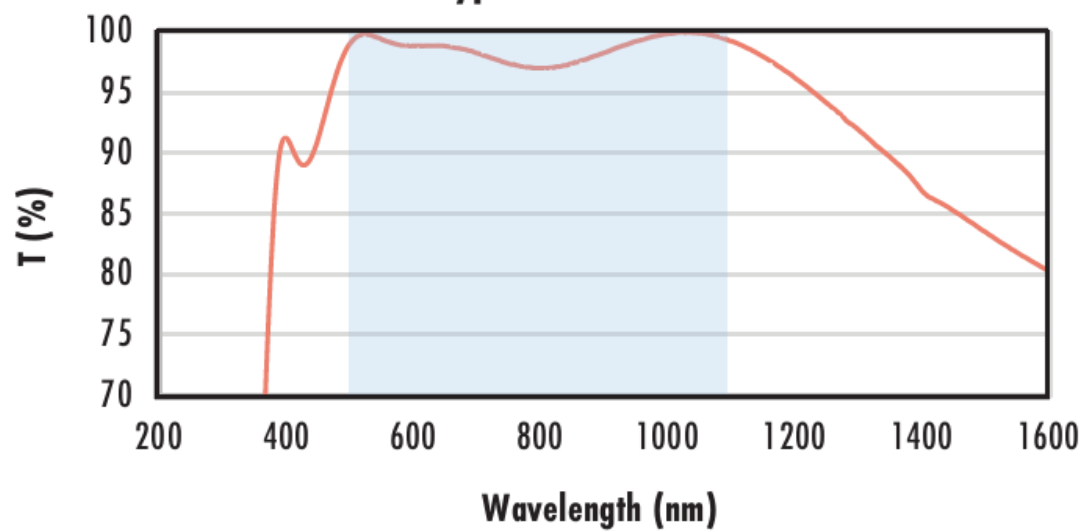

Typical transmission of a 3mm thick N-BK7 window with YAG-BBAR (500-1100nm) coating at 0° AOI.

The blue shaded region indicates the coating design wavelength range, with the following specification:

$$R_{abs} \leq 0.25\% @ 532\text{nm}$$

$$R_{abs} \leq 0.25\% @ 1064\text{nm}$$

$$R_{avg} \leq 1.0\% @ 500 - 1100\text{nm}$$

Data outside this range is not guaranteed and is for reference only.

[Click Here to Download Data](#)

N-BK7 with NIR I Coating Typical Transmission

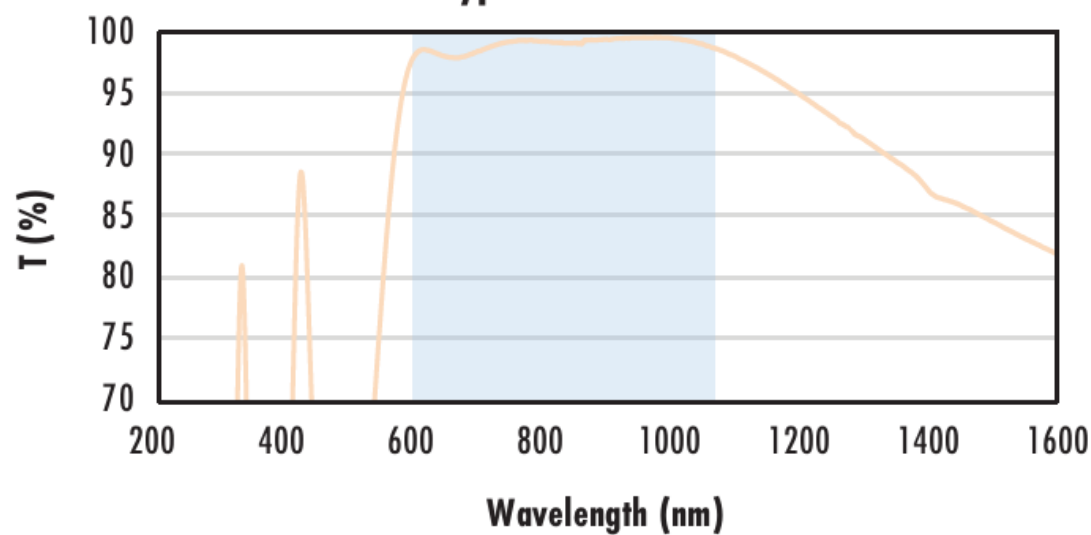

Typical transmission of a 3mm thick N-BK7 window with NIR I (600 - 1050nm) coating at 0° AOI.

The blue shaded region indicates the coating design wavelength range, with the following specification:

$$R_{avg} \leq 0.5\% @ 600 - 1050\text{nm}$$

Data outside this range is not guaranteed and is for reference only.

[Click Here to Download Data](#)

N-BK7 with NIR II Coating Typical Transmission



Typical transmission of a 3mm thick N-BK7 window with NIR II (750 - 1550nm) coating at 0° AOI.

The blue shaded region indicates the coating design wavelength range, with the following specification:

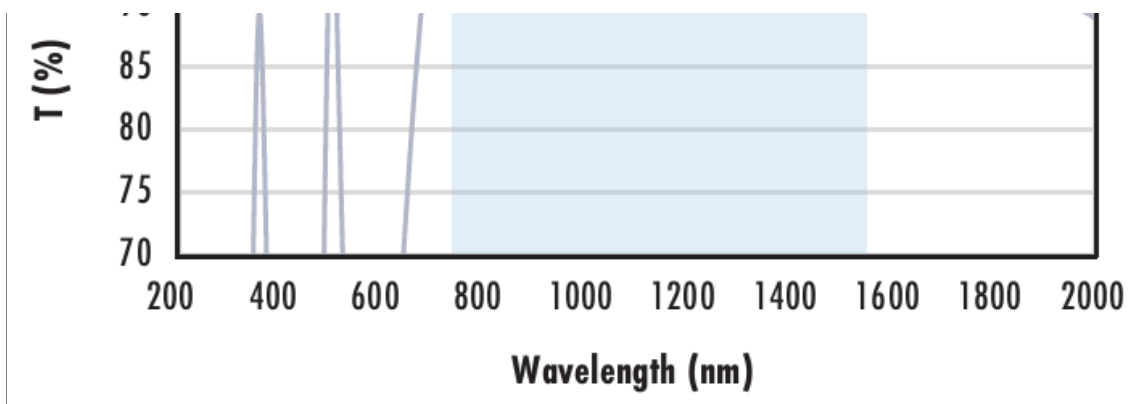

$R_{abs} \leq 1.5\%$ @ 750 - 800nm
 $R_{abs} \leq 1.0\%$ @ 800 - 1550nm
 $R_{avg} \leq 0.7\%$ @ 750 - 1550nm

Data outside this range is not guaranteed and is for reference only.

[Click Here to Download Data](#)

Coating Curves