

TECHSPEC® f/1.9, 6mm Focal Length Green Series M12 Lens



6mm Focal Length

Stock #87-231 **20+ In Stock**

- 1 + C\$140.⁰⁰

ADD TO CART

Volume Pricing	
Qty 1-49	C\$140.00 each
Qty 50+	C\$111.30 each
Need More?	Request Quote

Product Downloads

General

Green Series **Product Family:**

M12 Imaging Lens **Type:**

No **IR Cut Filter:**

Standard Lens **Imaging Lens Type:**

Physical & Mechanical Properties

Fixed	Iris Option:
11.70	Length (mm):
14	Maximum Diameter (mm):
14	Outer Diameter (mm):
3	Weight (g):

Optical Properties

Horizontal Field of View @ Max Sensor Format:
129.8mm - 46.2°

Field of View at Max Sensor Format:
Horizontal: 129.8mm - 46°
Vertical: 95.2mm - 34.6°
Diagonal: 168.5mm - 57.7°

Horizontal Field of View, 1/3" Sensor:
129.8mm - 46.2°

Horizontal Field of View, 1/4" Sensor:
95.1mm - 34.7°

Resolution:
80 lp/mm @ 20% Contrast

Maximum Image Circle (mm):
6.00

Numerical Aperture NA, Object Side:
0.0100

Number of Elements (Groups):
5(5)

Wavelength Range (nm):
400 - 700

Focal Length FL (mm):
6.00

Working Distance (mm):
150 - ∞

Aperture (f/#):
f/1.9

Distortion (%):
-8.27 @ Full Field

Back Focal Length BFL (mm):
4.0 - 3.9

Coating Specification:
M4 MgF₂ @ 580nm

Entrance Pupil Position (mm):
3.99

Object Space Principal Plane (mm):
6.38

Image Space Principal Plane (mm):
-1.43

Maximum Distortion (%):
-8.27

Exit Pupil Position (mm):
-5.43

Lens Wavelength Range:
VIS

Sensor

Maximum Sensor Format:
1/3"

Pixel Size (μm):
8.30

Threading & Mounting

Filter Thread:
N/A

Mounting Threads:
M12 x 0.5

Mount:
S-Mount (M12 x 0.5)

Regulatory Compliance

Compliant

RoHS 2015:

View

Certificate of Conformance:

Compliant

REACH 241:

Product Details

- Up to 1/2", S-Mount Lens
- Up to 0.4 MegaPixels, 8.3µm Pixel Size Sensors
- Board Camera Lens Optimized for Close WD and Finite Conjugate
- 6mm to 25mm Focal Lengths

TECHSPEC® Green Series M12 Lenses designed for use in compact and board level cameras provide excellent image quality in a small, versatile package. Optimized to cover 1/3" and 1/2" sensor formats and weighing only a few grams, these machine vision lenses meet the most demanding space and weight restrictions. Each lens is threaded for M12 x0.5, except the 25.0mm focal length option ([#54-855](#)). TECHSPEC® Green Series M12 Lenses are ideal for wide angle and close focus applications, large area inspect for the automotive, forensic, pharmaceutical, and food industries. Prescription data is available by submitting a [Request for Prescription Form](#).

Note: Compatible [TECHSPEC M12 Imaging Lens Accessories](#) available.

Edmund Optics has created multiple product families of our TECHSPEC® M12 S-Mount Lenses, which are designed to provide high resolution. These high performance lenses feature precision glass designs in a metal housing and have optimized specifications between each product family to meet your application needs.

- [Blue Series M12 Lenses](#): High resolution finite conjugate designs optimized for machine vision working distances.
- [Rugged Blue Series M12 Lenses](#): [Stabilized ruggedization](#) versions of our Blue Series M12 Lenses, utilizing the same optics.
- [Green Series M12 Lenses](#): Finite conjugate designs optimized for machine vision working distances.
- [Red Series M12 Lenses](#): Infinite conjugate designs optimized for high resolution performance out to infinity.
- [HEO Series M12 Lenses](#): Harsh Environment Optics (HEO) sealed versions of our Red Series M12 Lenses.
- [Liquid Lens M12 Lenses](#): Integrated liquid lens for fast electronic focus.

Technical Information

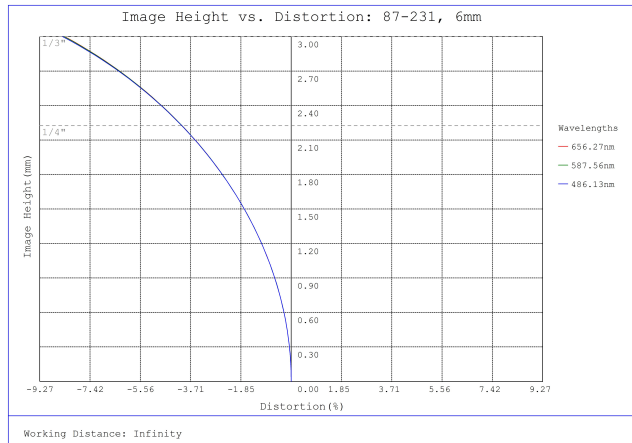

#87-231, f/1.9, 6mm Focal Length Green Series M12 Lens, Distortion Plot

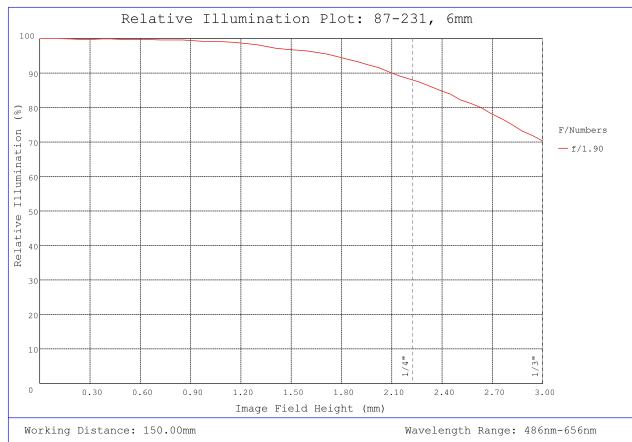

#87-231, f/1.9, 6mm Focal Length Green Series M12 Lens, Relative Illumination Plot

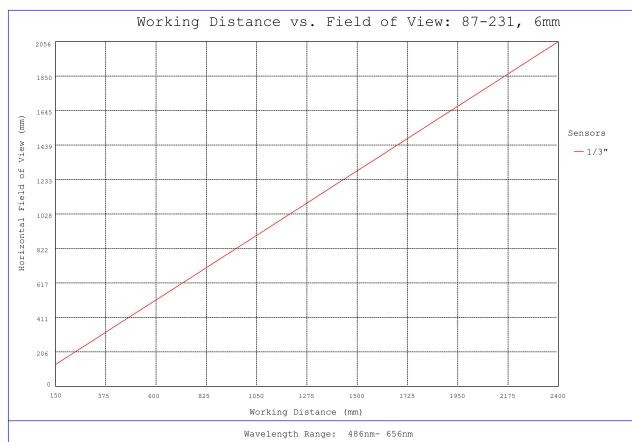

#87-231, f/1.9, 6mm Focal Length Green Series M12 Lens, Working Distance versus Field of View Plot

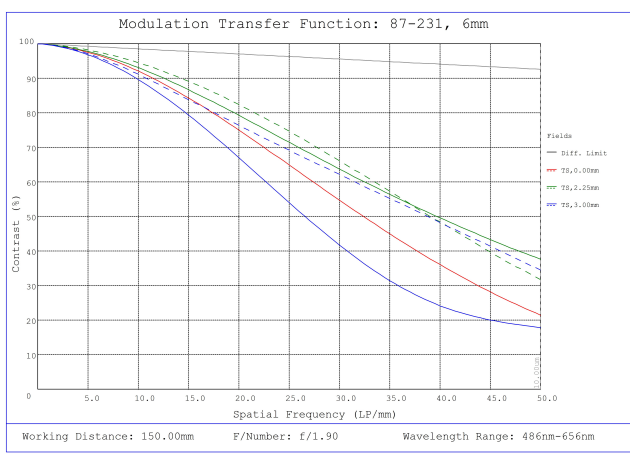

#87-231, f/1.9, 6mm Focal Length Green Series M12 Lens, Modulated Transfer Function (MTF) Plot, 150mm Working Distance, f1.9

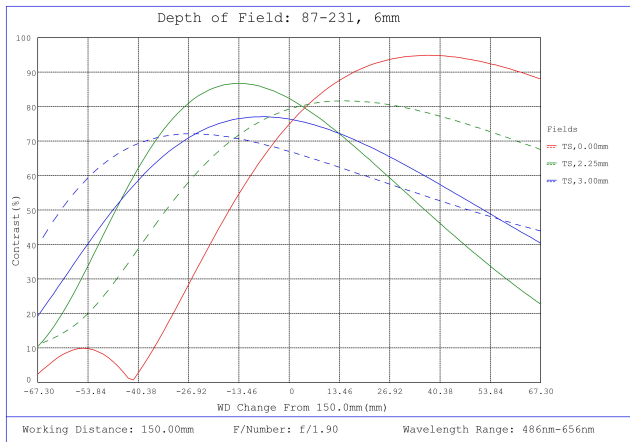

#87-231, f/1.9, 6mm Focal Length Green Series M12 Lens, Depth of Field Plot, 150mm Working Distance, f1.9

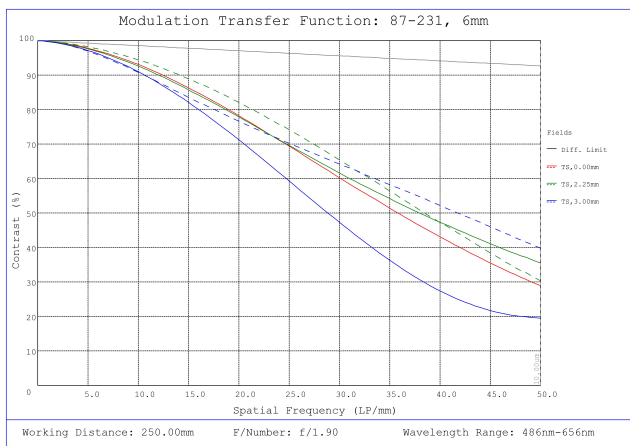

#87-231, f/1.9, 6mm Focal Length Green Series M12 Lens, Modulated Transfer Function (MTF) Plot, 250mm Working Distance, f1.9

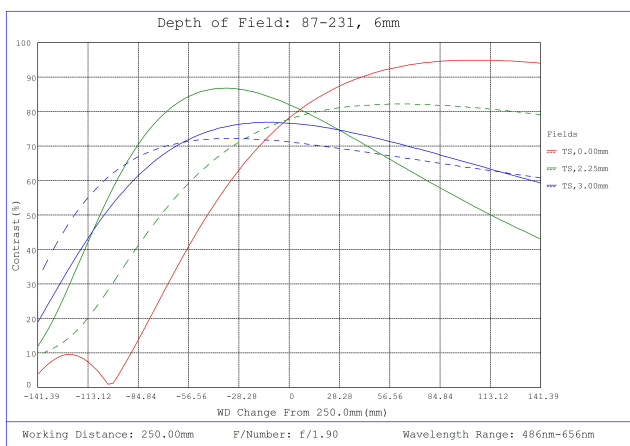

#87-231, f/1.9, 6mm Focal Length Green Series M12 Lens, Depth of Field Plot, 250mm Working Distance, f1.9

Focal Length	A	B	C**	D	Mounting Thread
6.00	14.0	11.70	4.0 - 3.9	3.5	M12 x 0.5
8.00	14.0	20.40	8.9 - 8.7	6.0	M12 x 0.5
12.00	16.0	19.50	7.1 - 6.75	6.0	M12 x 0.5
25.00	18.0	24.40	12.6 - 11.9	9.0	M16 x 0.5

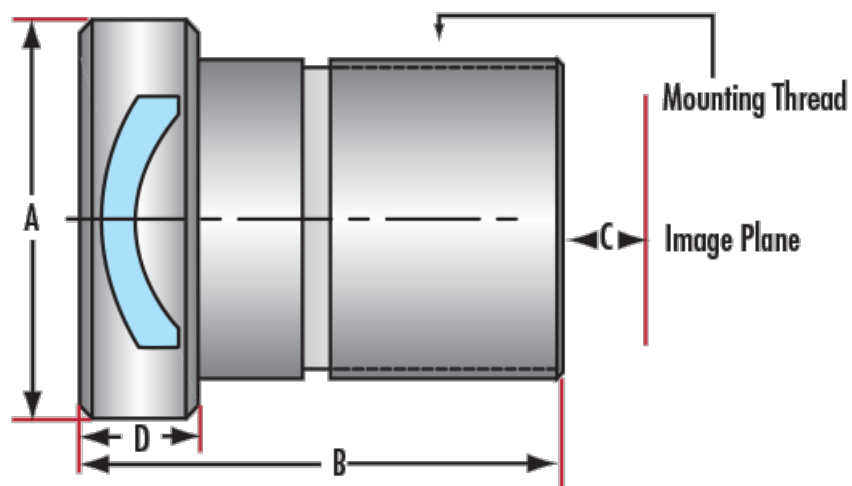

**Minor adjustment required to match WD limits.

