

**TECHSPEC® f/8, 6mm Focal Length Green Series M12 Lens**



6mm Focal Length

Stock #83-945 **20+ In Stock**

⊖ 1 ⊕ C\$133<sup>00</sup>

**ADD TO CART**

Volume Pricing	
Qty 1-49	C\$133.70 each
Qty 50+	C\$111.30 each
Need More?	<a href="#">Request Quote</a>

Product Downloads

**General**

Green Series **Product Family:**

M12 Imaging Lens **Type:**

No **IR Cut Filter:**

Standard Lens **Imaging Lens Type:**

## Physical & Mechanical Properties

Fixed	<b>Iris Option:</b>
11.70	<b>Length (mm):</b>
14	<b>Maximum Diameter (mm):</b>
14	<b>Outer Diameter (mm):</b>
3	<b>Weight (g):</b>

## Optical Properties

**Horizontal Field of View @ Max Sensor Format:**  
130.1mm - 46.3°

**Field of View at Max Sensor Format:**  
Horizontal: 129.8mm - 46°  
Vertical: 95.2mm - 34.6°  
Diagonal: 168.5mm - 57.7°

**Horizontal Field of View, 1/3" Sensor:**  
129.8mm - 46.2°

**Horizontal Field of View, 1/4" Sensor:**  
95.1mm - 34.7°

**Resolution:**  
80 lp/mm @ 20% Contrast

**Maximum Image Circle (mm):**  
6.00

**Numerical Aperture NA, Object Side:**  
0.0024

**Number of Elements (Groups):**  
5(5)

**Wavelength Range (nm):**  
400 - 700

**Focal Length FL (mm):**  
6.00

**Working Distance (mm):**  
150 - ∞

**Aperture (f/#):**  
f/8

**Distortion (%):**  
-8.27 @ Full Field

**Back Focal Length BFL (mm):**  
4.0 - 3.9

**Coating Specification:**  
M4 MgF<sub>2</sub> @ 580nm

**Entrance Pupil Position (mm):**  
3.99

**Object Space Principal Plane (mm):**  
6.38

**Image Space Principal Plane (mm):**  
-1.43

**Maximum Distortion (%):**  
-8.27

**Exit Pupil Position (mm):**  
-5.43

**Lens Wavelength Range:**  
VIS

## Sensor

**Maximum Sensor Format:**  
1/3"

**Pixel Size (µm):**  
8.30

## Threading & Mounting

**Filter Thread:**  
N/A

**Mounting Threads:**  
M12 x 0.5

**Mount:**  
S-Mount (M12 x 0.5)

## Regulatory Compliance

Compliant

RoHS 2015:

View

Certificate of Conformance:

Compliant

REACH 241:

## Product Details

- Up to 1/2", S-Mount Lens
- Up to 0.4 MegaPixels, 8.3µm Pixel Size Sensors
- Board Camera Lens Optimized for Close WD and Finite Conjugate
- 6mm to 25mm Focal Lengths

TECHSPEC® Green Series M12 Lenses designed for use in compact and board level cameras provide excellent image quality in a small, versatile package. Optimized to cover 1/3" and 1/2" sensor formats and weighing only a few grams, these machine vision lenses meet the most demanding space and weight restrictions. Each lens is threaded for M12 x0.5, except the 25.0mm focal length option (#54-855). TECHSPEC® Green Series M12 Lenses are ideal for wide angle and close focus applications, large area inspect for the automotive, forensic, pharmaceutical, and food industries. Prescription data is available by submitting a [Request for Prescription Form](#).

**Note:** Compatible [TECHSPEC M12 Imaging Lens Accessories](#) available.

Edmund Optics has created multiple product families of our TECHSPEC® M12 S-Mount Lenses, which are designed to provide high resolution. These high performance lenses feature precision glass designs in a metal housing and have optimized specifications between each product family to meet your application needs.

- **Blue Series M12 Lenses:** High resolution finite conjugate designs optimized for machine vision working distances.
- **Rugged Blue Series M12 Lenses:** Stabilized ruggedization versions of our Blue Series M12 Lenses, utilizing the same optics.
- **Green Series M12 Lenses:** Finite conjugate designs optimized for machine vision working distances.
- **Red Series M12 Lenses:** Infinite conjugate designs optimized for high resolution performance out to infinity.
- **HEO Series M12 Lenses:** Harsh Environment Optics (HEO) sealed versions of our Red Series M12 Lenses.
- **Liquid Lens M12 Lenses:** Integrated liquid lens for fast electronic focus.

## Technical Information

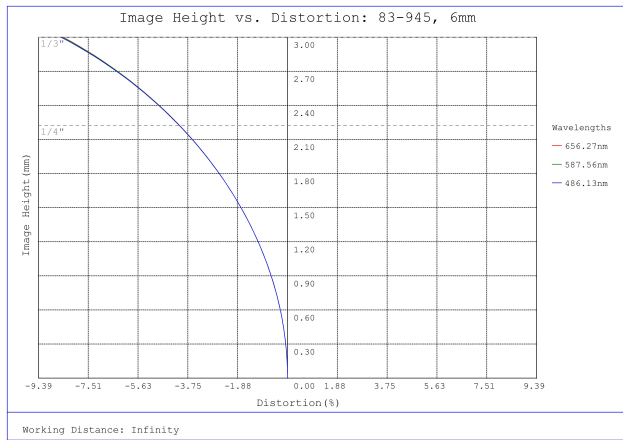

#83-945, f/8, 6mm Focal Length Green Series M12 Lens, Distortion Plot

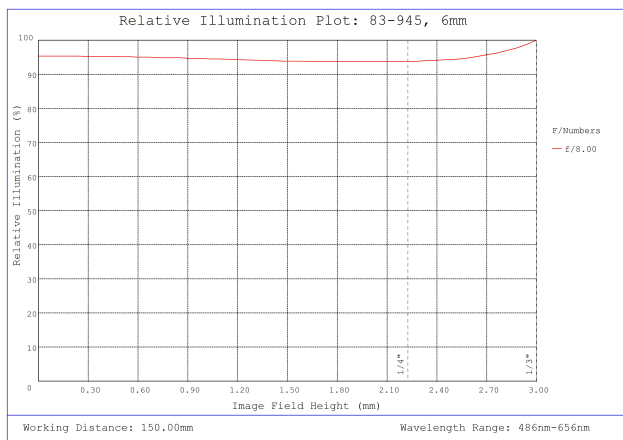

#83-945, f/8, 6mm Focal Length Green Series M12 Lens, Relative Illumination Plot

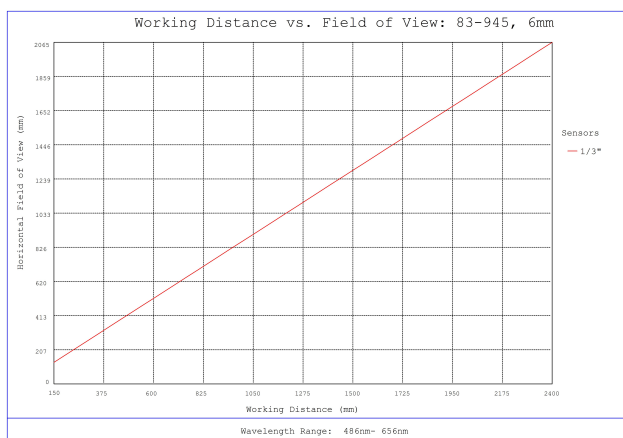

#83-945, f/8, 6mm Focal Length Green Series M12 Lens, Working Distance versus Field of View Plot

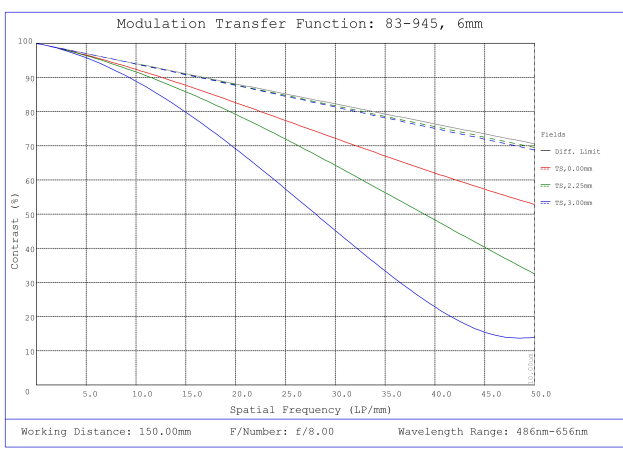

#83-945, f/8, 6mm Focal Length Green Series M12 Lens, Modulated Transfer Function (MTF) Plot, 150mm Working Distance, f8

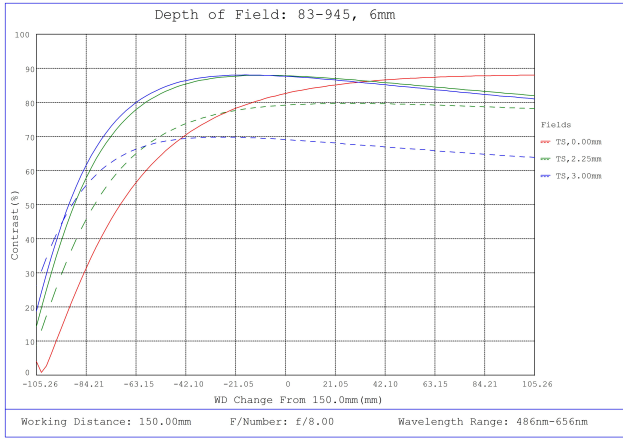

#83-945, f/8, 6mm Focal Length Green Series M12 Lens, Depth of Field Plot, 150mm Working Distance, f8

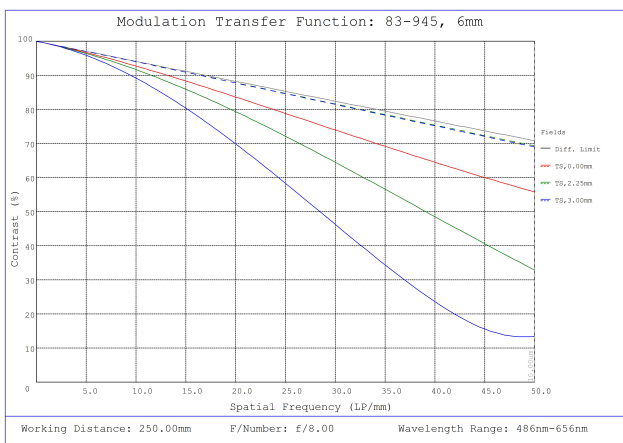

#83-945, f/8, 6mm Focal Length Green Series M12 Lens, Modulated Transfer Function (MTF) Plot, 250mm Working Distance, f8

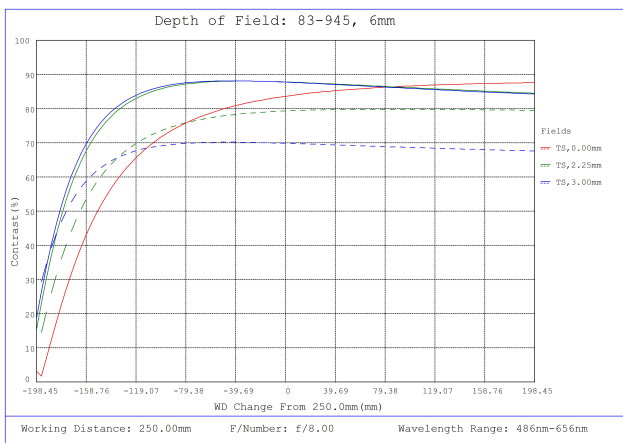

#83-945, f/8, 6mm Focal Length Green Series M12 Lens, Depth of Field Plot, 250mm Working Distance, f8

Focal Length	A	B	C**	D	Mounting Thread
6.00	14.0	11.70	4.0 - 3.9	3.5	M12 x 0.5
8.00	14.0	20.40	8.9 - 8.7	6.0	M12 x 0.5
12.00	16.0	19.50	7.1 - 6.75	6.0	M12 x 0.5
25.00	18.0	24.40	12.6 - 11.9	9.0	M16 x 0.5

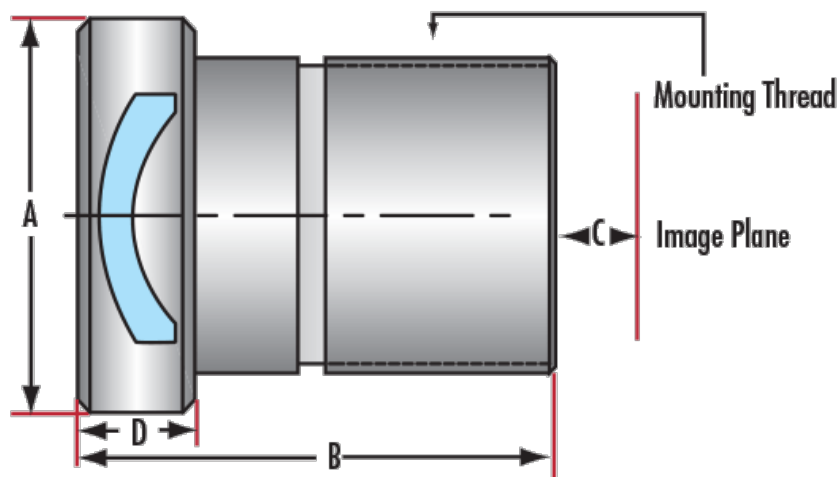

\*\*Minor adjustment required to match WD limits.

